



HTG889

8-Channel Mosfet Amplifier
2 Ohm Stereo Stable with High Pass
and Low Pass Filter Controls



HTG559BT

5-Channel Mosfet Amplifier
with Wireless BT Audio Interface
2 Ohm Stereo Stable with High Pass
and Low Pass Filter Controls

HTG669BT

6-Channel Mosfet Amplifier
with Wireless BT Audio Interface
2 Ohm Stereo Stable with High Pass
and Low Pass Filter Controls



USER GUIDE

INTRODUCTION

LANZAR amplifiers provide high-performance sound reinforcement for your mobile audio equipment. Its versatility enables compatibility with optional Equalizers, Frequency Dividing Crossover Networks, and other audio processors in a customized system. The Multi-Mode bridging capabilities allow flexibility in hosting several different speaker configurations.

To achieve optimum performance, it is highly recommended that you read this Owners Manual before beginning installation.

WARNING

High powered audio systems in a vehicle are capable of generating "Live Concert" high levels of sound pressure. Continued exposure to excessively high volume sound levels may cause hearing loss or damage. Also, operation of a motor vehicle while listening to audio equipment at high volume levels may impair your ability to hear external sounds such as; horns, warning signals, or emergency vehicles, thus contributing to a potential traffic hazard. In the interest of safety, **LANZAR** recommends listening at lower volume levels while driving.

TABLE OF CONTENTS

PLANNING YOUR SYSTEM	3
WIRING CONNECTION	4
PANEL LAYOUT	5
CONTROL FUNCTIONS	7
SPEAKER DIAGRAMS MONO CHANNEL	9
TROUBLESHOOTING GUIDE	14
WARNINGS	14
SPECIFICATION	15

PLANNING YOUR SYSTEM

Before beginning the installation, consider the following:

1. Do you plan to add additional mobile electronics equipment in the future?

If you plan to expand your system by adding other components sometime in the future, ensure adequate space is left and cooling requirements are met.

2. Should you use high or low level inputs?

Your Amplifier has been designed to accept Low-Level (Pre-Amp outputs from your radio) source signal. If your radio/source is equipped with Pre-Amp outputs, it is possible to utilize them to drive the Amplifier and the 2 front speakers.

Then, use the built-in power of your radio to drive the 2 rear speakers.

3. Are your components matched?

The RMS power rating of your speaker(s) must be equal or greater than the RMS power rating of your amplifier. Your speaker(s) also must be 2- 8 Ohms impedance for stable amplifier operation. Impedance information is normally printed on the speaker basket or magnet.

4. Where will the amplifier be installed?

Consider both the length of your leads, and routing when determining the mounting location. It is best to run power and RCA wiring on opposite sides of the vehicle to prevent induced noise. Pre-amp input jacks require a length of high quality shielded male to male RCA patch cord.

CONNECTING THE POWER

CAUTION

AS A PRECAUTION, DISCONNECT THE POWER WIRE FROM THE BATTERY WHILE MAKING THE POWER AND GROUND CONNECTIONS TO THE AMPLIFIER.

4/8 GAUGE (Thicker if planning for additional Amplifiers) wire is recommended for both the power and ground wires 12 Gauge, for the remote turn-on wire 16 Gauge. Both types are available at most Mobile Audio Dealers or Installation Shop.

WIRING CONNECTION

1. Ground: To Vehicle Chassis

To avoid unwanted ignition noise caused by ground loop, it is essential that the Amplifier be grounded to a clean, bare, metal surface of the vehicle's Chassis

NOTE:

GROUND WIRE SHOULD NOT BE EXTENDED MORE THAN 3 FT. (1 METER).

2. +12 Volt (Fused) Constant Power: To Battery (+)

Due to the power requirements of the Amplifier, this connection should be made directly to the positive (+) terminal of battery. For safety measures, install an in-line Fuse Holder (not included) as close to the battery positive (+) terminal as possible with an ampere rating; not to exceed total value of fuses in Amp.

3. Remote Turn-On Input: To remote turn-on output of Car Stereo

This Amplifier is turned "ON" remotely when the vehicle's stereo is turned "ON".

NOTE:

IF YOUR RADIO DOES NOT HAVE A +12 VOLT OUTPUT LEAD WHEN THE RADIO IS TURNED ON, THE "REMOTE" TERMINAL ON THE AMPLIFIER CAN BE CONNECTED TO VEHICLE'S ACCESSORY CIRCUIT THAT IS LIVE WHEN THE KEY IS "ON".

HTG559BT - HTG669BT

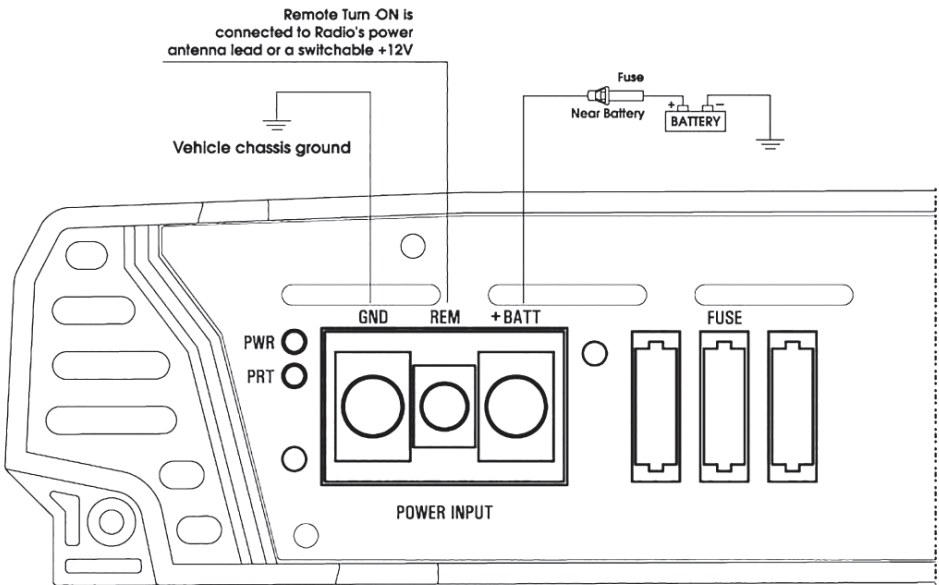

HTG889

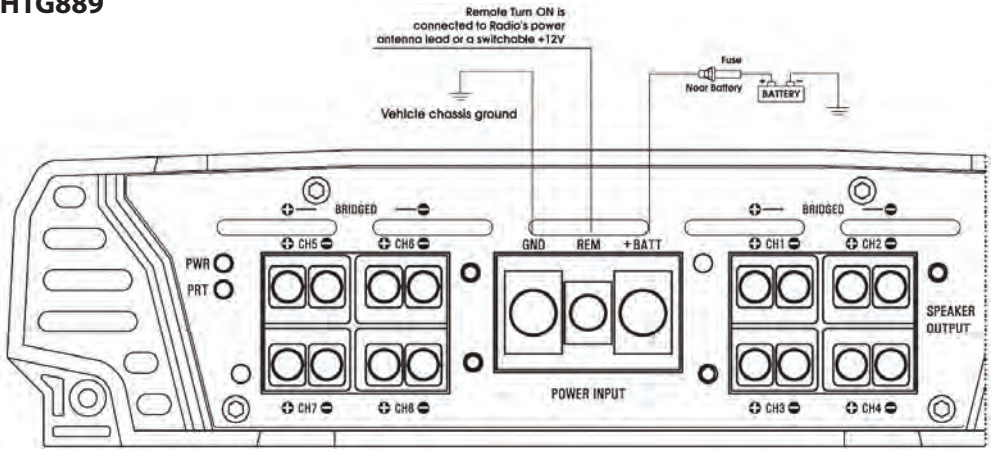

PANEL LAYOUT

HTG559BT - HTG669BT Front View

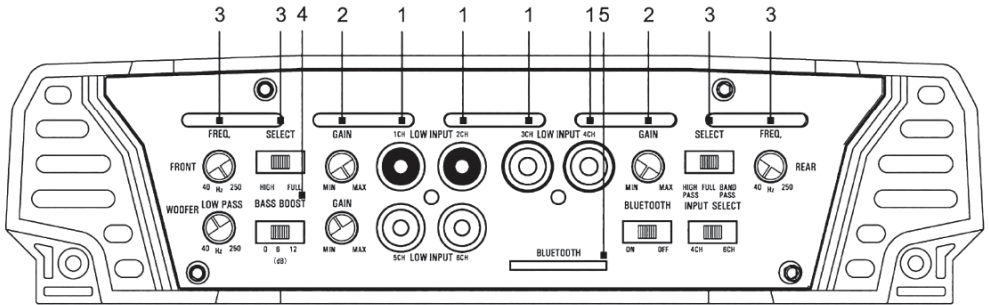

HTG889 Front View

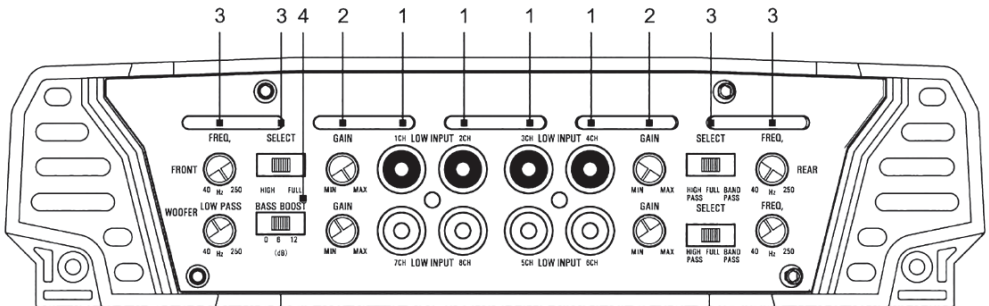

Rear View
HTG559BT

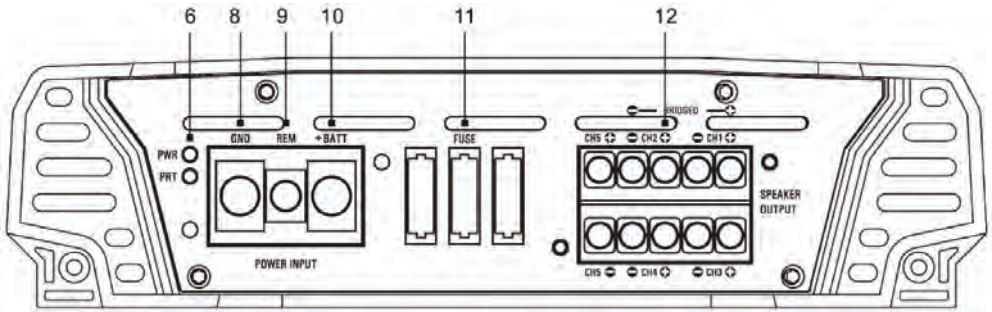

HTG669BT

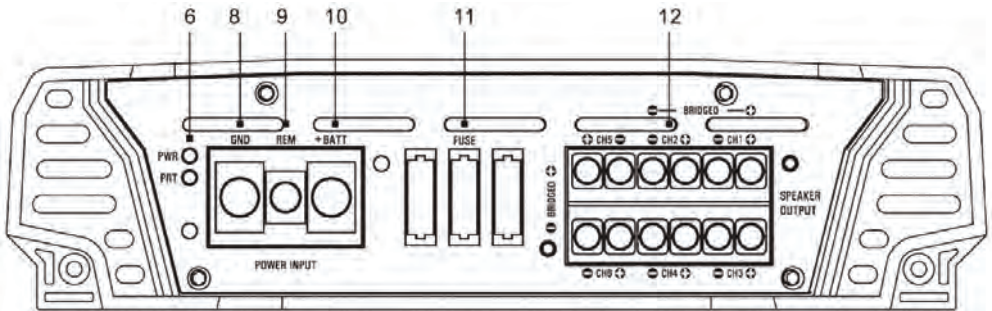

HTG889

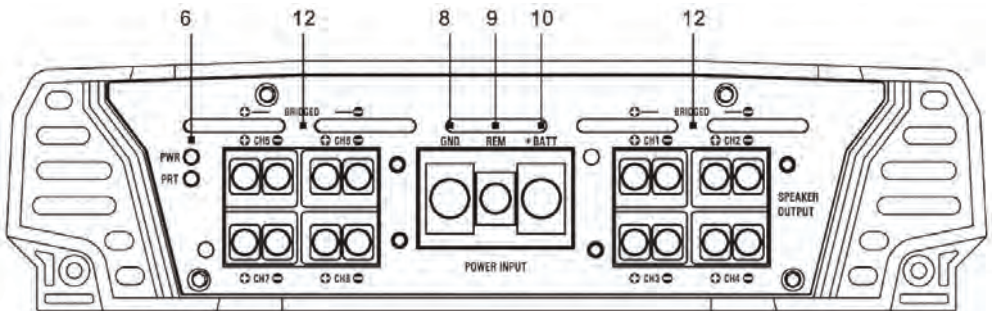

CONTROL FUNCTIONS

1. RCA Input jacks

These RCA input jacks are for use with source units that have RCA or Line level outputs. A source unit with a minimum level of 200mV is required for proper operation. The use of high quality twisted pair cables is recommended to decrease the possibility of radiated noise entering the system.

2. GAIN Control

The level control will match the amplifiers sensitivity to the source units signal voltage. The Operating range is 200mV minimum to 6V maximum.

CAUTION: Do not run the amplifier in high volume for long time, otherwise the loudspeakers will be damaged.

3. X-OVER (SELECT)

• Full pass x-over switch

When the switch is in the "Full" position, the full range is bypassed.

• Low pass x-over switch

When the switch is in the "LPF" position, frequencies lower than the low pass frequency setting are passed.

The frequency can be adjusted between 40Hz and 250Hz.

• High pass x-over switch

When the switch is in the "HPF" position, frequencies higher than the high pass frequency setting are passed.

The frequency is 40Hz-250Hz

• Band Pass select switch

When the switch is in the "Band Pass" position, the band pass range is by passed: 50Hz-2.5KHz.

4. Bass BOOST

The boost can be selected among 0dB, 6dB and 12dB.

5. Wireless BT Streaming

Wireless BT receiver.

Warning:

Do not connect a level control knob from other manufacturers to the Remote Sub Level Control of any amplifier. Even though the connectors fit properly, the control knob and connector pin positions may be different and the amplifier will be damaged.

6. LED

Will illuminate GREEN to indicate the amplifier is on and operating normally, and will be illuminated RED if the amplifier shuts down due to short circuit, DC offset, or overheating detected by on board protection circuitry.

7. Auxiliary Outputs

The Auxiliary outputs offer LANZAR amplifiers easy, unlimited system expansion. Route RCA's from the line out of the first amplifier to the line input of a second amplifier when using a single source output.

8. GND

Connect this terminal directly to the sheet metal chassis of the vehicle, using the shortest wire necessary to make this connection. Always use wire of the same gauge or larger than the (+)12 volt power wire. The chassis connection point should be scraped free of paint and dirt. Use only quality crimped and/or soldered connectors at both ends of this wire.

Warning: Do not connect this terminal directly to the vehicle battery ground terminal or any other factory ground points.

9. Remote Turn On

This terminal turns on the amplifier when (+)12 volt is applied to it. Connect it to the remote turn on lead of the head unit or signal source.

10. (+)12 Volt Power

Connect this terminal through a FUSE or CIRCUIT BREAKER to the positive terminal of the vehicle battery or the positive terminal of an isolated audio system battery.

Warning: Always protect this power wire by installing a fuse or circuit breaker of the appropriate size within 12 inches of the battery terminal connection.

11. FUSE

These fuses protect the amplifier against internal electrical damage and are meant to protect the amplifier only. All other power connections should be fused at the source.

12. SPEAKERS

Connect subwoofers to these terminals.

System Diagrams

5 Channel Systems

HTG559BT

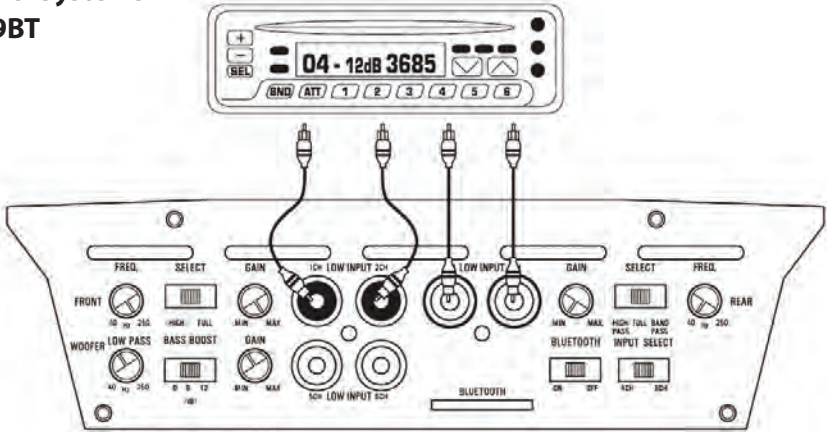

Design #1

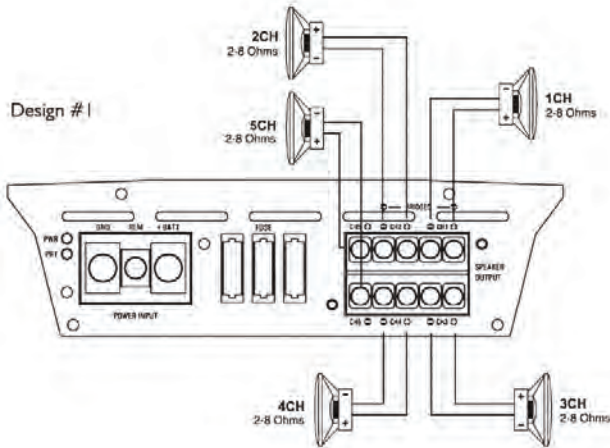

Design #2

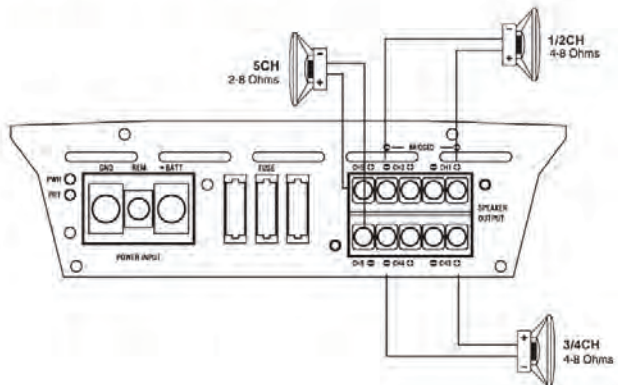

System Diagrams

6 Channel Systems

HTG669BT

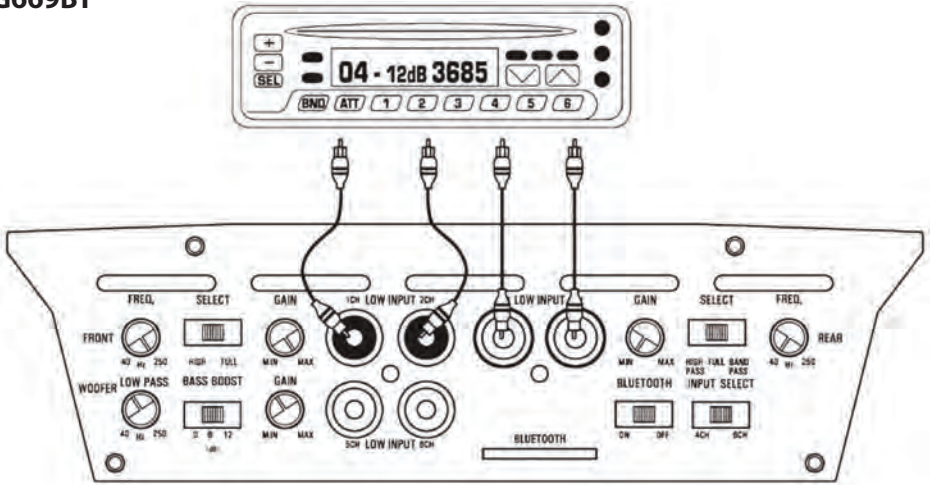

Design #1

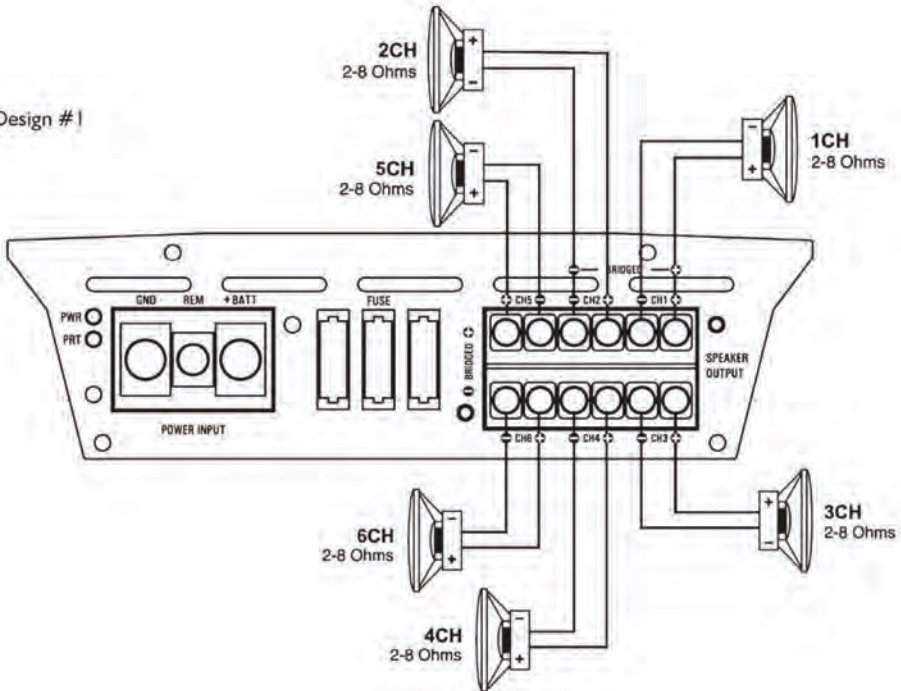

System Diagrams

Design #2

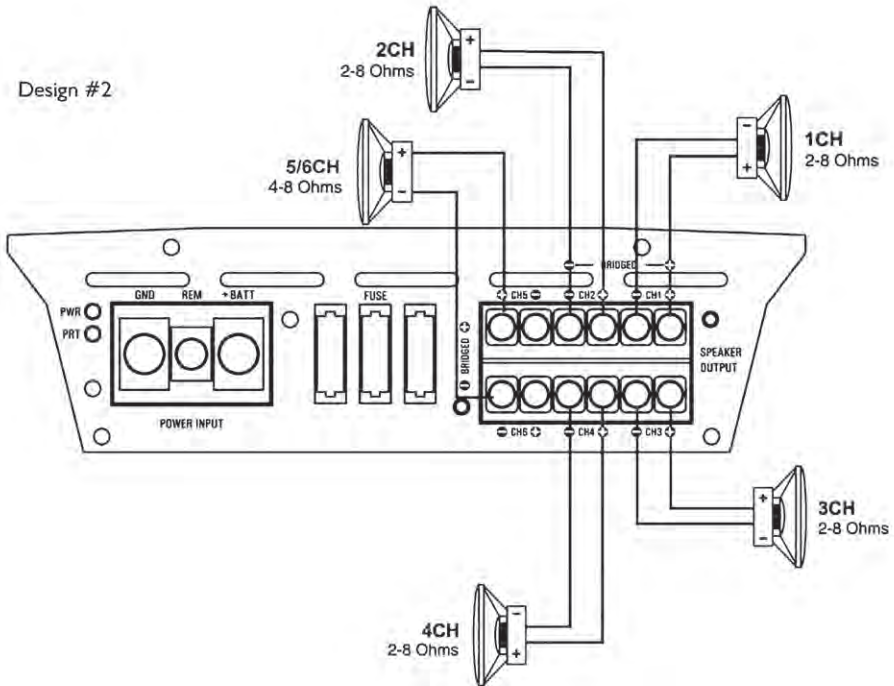

Design #3

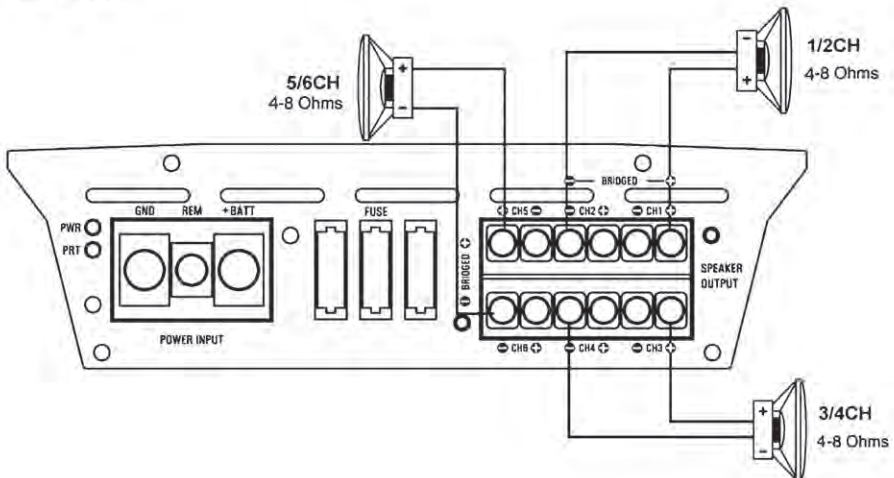

System Diagrams

8 Channel Systems

HTG889

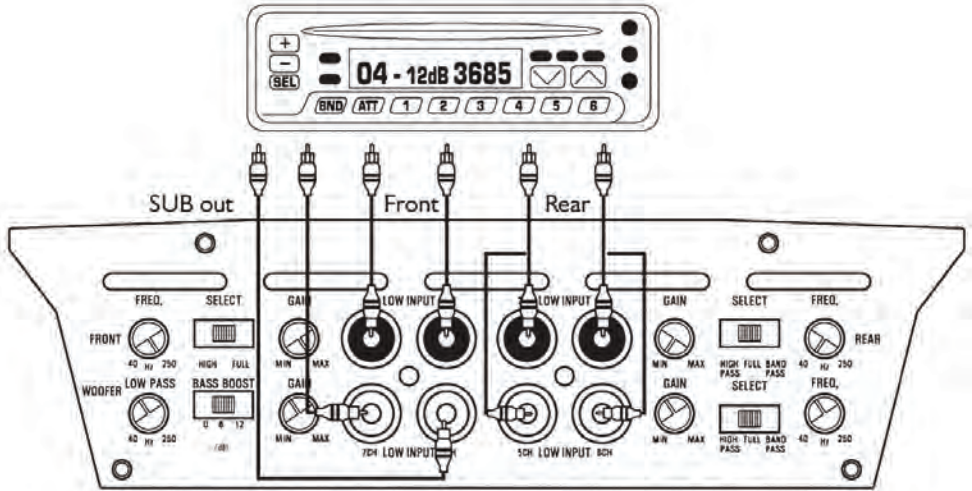

Design # 1

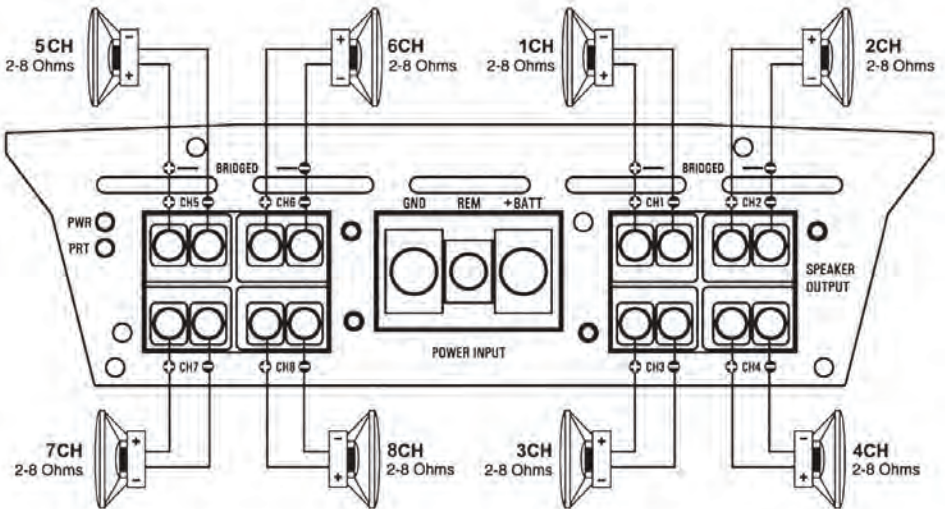

System Diagrams

Design #2

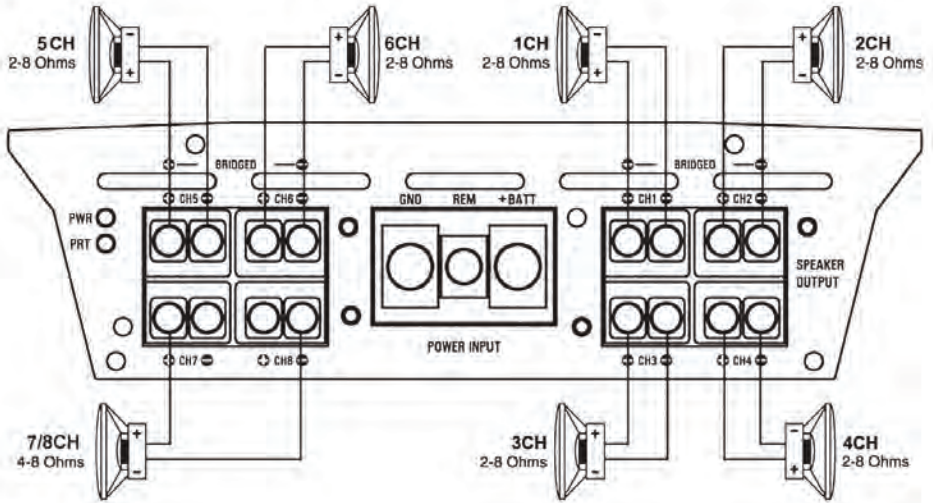

Design #3

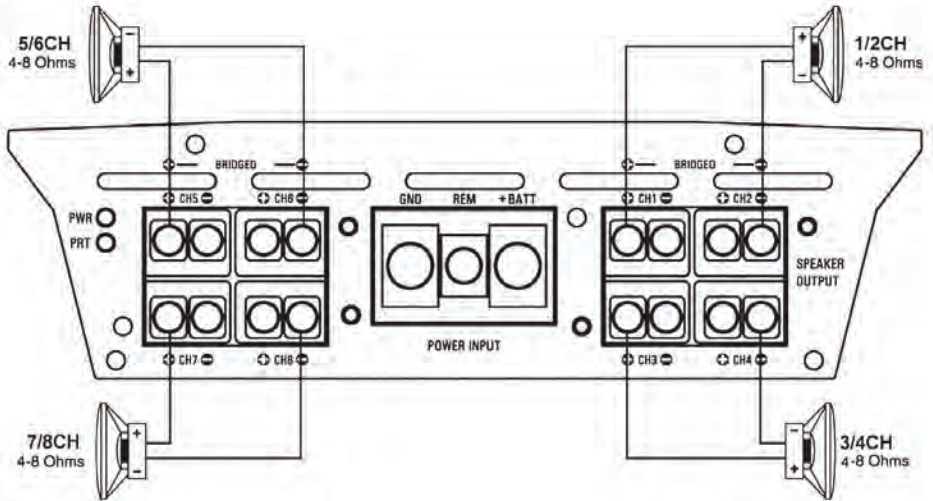

California Prop 65 Warning

⚠ WARNING:

This product contains Nickel carbonate which is known to the state of California to cause cancer birth defects and other reproductive harm. Do not ingest.

For more info go to: www.P65warnings.ca.gov

TROUBLESHOOTING GUIDE

SYMPTOMS	CHECK POINTS	CURE
NO SOUND	Is the power LED illuminated?	Check fuses in amplifier. Be sure Turn-on lead is connected
AMP NOT SWITCHING ON	No power to power wire	Repair power wire or connections
	No power to remote wire with receiver on	Check connections to radio
	Fuse broken	Check fuse
NO SOUND IN ONE CHANNEL	Check speaker leads	Inspect for short circuit or an open connection.
	Check audio input leads	Reverse Left and Right RCA inputs to determine if it is occurring before the amp. Check Tuner/Deck volume level. Clean contacts on fuse holders.
AMP TURNING OFF MEDIUM/HIGH VOLUME	Check speaker load impedance	Be sure proper speakers are used to ensure impedance recommendations are observed. (If you use an Ohmmeter to check speaker resistance, please remember that DC resistance and AC impedance may not be the same.)

WARNINGS

Investigate the layout of your automobile thoroughly before drilling or cutting any holes. Take care when to work near the gas tanks, lines, or hydraulic lines, and electrical wiring. Don't use power amplifier unmounted. Attach this system securely to the auto-mobile to prevent damage, particularly in the event of an accident. Don't mount this system so that the wire connections are unprotected or are subject to pinching or damage from nearby objects. The +12V DC power wire must be fused at the battery positive terminal connection. Before making or breaking power connections at this system power terminals, disconnect the +12V wire at the battery end. Confirm your radio/cassette player and/or other equip is turned off while connecting the input jacks and speaker terminals. If you need to replace the power fuse, replace it only with a fuse identical to that supplied with the system. Using a fuse of different type or rating may result in damage to this system which isn't covered by the warranty.

Specification

HTG889

8-Channel Mosfet Amplifier

2 Ohm Stereo Stable with High Pass and Low Pass Filter Controls

Features:

- Class "AB" High-Current Dual Discrete Drive Stages
- Mosfet PWM Power Supply
- Bass Boost Circuit
- Bridgeable at 4ohms
- 2 Ohm Stereo Stable
- Chrome RCA Inputs, Power Speaker Terminals
- Stereo Line Outputs for Left and Right Channel
- Low Pass Filter Controls
- High Pass Filter Controls
- Band Pass Filter Controls
- 5 Way Protections
- Power and Protection LED Indicators
- Soft Turn-on/Turn-off

Technical Specs:

- 8 X 250W RMS @ 4 Ohms
- 8 X 350W RMS @ 2 Ohms
- 4 X 1,000W MAX @ 4 Ohms Bridged
- 8 X 500W MAX @ 4 Ohms
- THD: <0.01%
- S/N Ratio: >90dB
- Channel Separation: >65dB
- Freq. Response: 10Hz-45KHz
- LPF Freq. Response: 40Hz-250Hz
- HPF Freq. Response: 40Hz-250Hz
- BPF Freq. Response: 40Hz-3KHz
- Bass Boost(50Hz): 0,6,12dB
- Input Sensitivity: 0.2V~6V
- Fuse: 100A
- Product Dimensions (L x W x H): 22.83" x 8.81" x 2.24" -inches



HTG559BT

5-Channel Mosfet Amplifier with Wireless BT Audio Interface

2 Ohm Stereo Stable with High Pass and Low Pass Filter Controls

Features:

- Wireless BT Audio Interface
- Class "AB" High-Current Dual Discrete Drive Stages
- Mosfet PWM Power Supply
- Bass Boost Circuit
- Bridgeable at 4 Ohms
- 2 Ohm Stereo Stable
- Chrome RCA inputs, Power Speaker Terminals
- Stereo Line Outputs for Left and Right Channel
- Low Pass Filter Controls
- High Pass Filter Controls
- Band Pass Filter Controls
- 5 Way Protections
- Power and Protection LED Indicators
- Soft Turn-on/Turn-off

Technical Specs:

- 4 X 250W + 1 X 650W RMS @ 4 Ohms
- 4 X 350W + 1 X 1,500W RMS @ 2 Ohms
- 2 X 1,000W MAX @ 4 Ohms Bridged
- 4 X 500W + 1 X 2,000W MAX @ 4 Ohms
- THD: <0.01%
- S/N Ratio: >90dB
- Channel Separation: >65dB
- Freq. Response: 10Hz-45KHz
- LPF Freq. Response: 40Hz-250Hz
- HPF Freq. Response: 40Hz-250Hz
- BPF Freq. Response: 40Hz-3KHz
- Bass Boost (50Hz): 0,6,12dB
- Input Sensitivity: 0.2V~6V
- Fuse: 30A X 3
- Product Dimensions (L x W x H): 19.29" x 8.81" x 2.24" -inches



HTG669BT

6-Channel Mosfet Amplifier with Wireless BT Audio Interface

2 Ohm Stereo Stable with High Pass and Low Pass Filter Controls

Features:

- Wireless BT Audio Interface
- Class "AB" High-Current Dual Discrete Drive Stages
- Mosfet PWM Power Supply
- Bass Boost Circuit
- Bridgeable at 4 Ohms
- 2 Ohm Stereo Stable
- Chrome RCA Inputs, Power Speaker Terminals
- Stereo Line Outputs for Left and Right Channel
- Low Pass Filter Controls
- High Pass Filter Controls
- Band Pass Filter Controls
- 5 Way Protections
- Power and Protection LED Indicators
- Soft Turn-on/Turn-off

Technical Specs:

- 6 X 250W RMS @ 4 Ohms
- 6 X 350W RMS @ 2 Ohms
- 3 X 1,000W MAX @ 4 Ohms Bridged
- 6 X 500W MAX @ 4 Ohms
- THD: <0.01%
- S/N Ratio: >90dB
- Channel Separation: >65dB
- Freq. Response: 10Hz-45KHz
- LPF Freq. Response: 40Hz-250Hz
- HPF Freq. Response: 40Hz-250Hz
- BPF Freq. Response: 40Hz-3KHz
- Bass Boost(50Hz) : 0,6,12dB
- Input Sensitivity:0.2V~6V
- Fuse: 25A X 3
- Product Dimensions (L x W x H): 19.29" x 8.81" x 2.24" -inches





Questions? Issues?

We are here to help!

Phone: (1) 718-535-1800

Email: support@lanzar.com