

SereneLife



IPCAMHD82EU 1080p IP Camera

HD WiFi Cam, Remote Video Monitoring Surveillance Security,
Built-In Speaker & Microphone, Smartphone App Control

USER MANUAL

TABLE OF CONTENTS:

PRODUCT STRUCTURE DIAGRAM	1
SETUP AN ACCOUNT USERNAME	2
ADD CAMERA TO APP	3
CONNECT TO YOUR NETWORK	4
WEB ACCESS	5
PASSWORDS	5
MOBILE APP LAYOUT	5
CAMERA VIEW PAGE	7
CAMERA RECORDINGS	8
DEVICE SETTINGS	9
RECORDING YOUR CAMERA	10
MOTION DETECTION AND NOTIFICATION SETTINGS EXPLAINED	11
HOW TO IMPROVE PLAYBACK PERFORMANCE	12
DECREASE THE VIDEO STREAM QUALITY	13
HOW TO EVALUATE YOUR HOME WIRELESS NETWORK	14
HOW TO CHECK AND INSTALL FIRMWARE UPDATES	15
TROUBLESHOOTING	17
FEATURES AND TECHNICAL SPECS	19

Product Structure Diagram

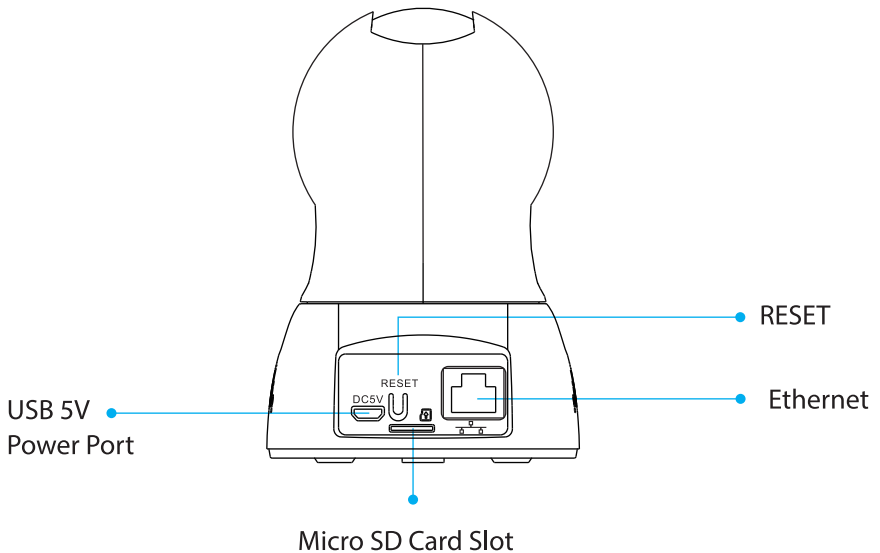
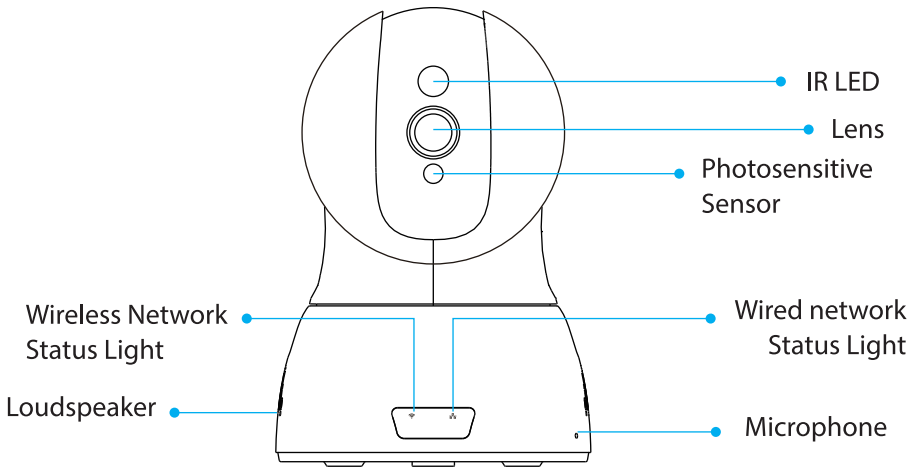

Don't forget to register your camera with us online to get a free 1 year manufacturer's warranty!

Just go to www.SereneLifeHome.com

'SereneViewer' APP Installation

A. Scan 'SereneViewer' APP QR code or search to download the app.



iOS



Andriod

Setup an Account Username



Click "Sign Up"

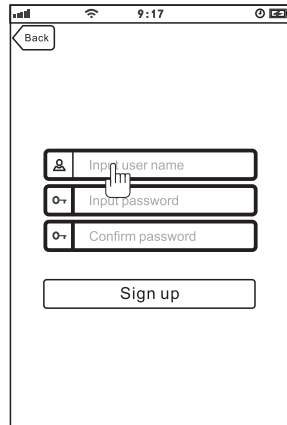

Create your camera username
- 6 characters min
- Do not use email address

Note:

This user name will be used to access all of your cameras from the app or PC.

Create an account password - Click "Sign Up"

Note: This will be used to log in to all of the cameras on your account and can be separate from the camera password

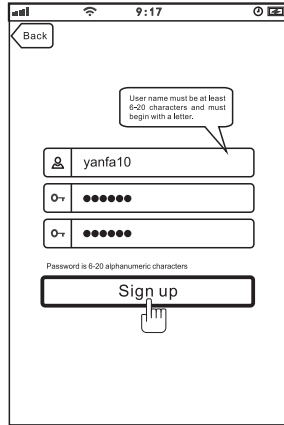

Add Camera to APP

1. Enter 'Device List' and click '+' icon at the top of left corner. Then scan the device ID QR code.

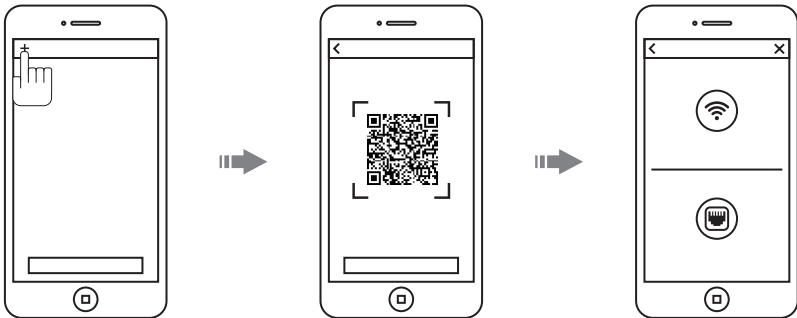

Connect to Your Network

Choose method 1 or 2 for setup

Method 1: Wired Setup

- Connect power, Ethernet cable as above.
- Wait 50 seconds for (Wi-Fi) indicator on the camera to flash green
- After scanning QR code - select the "Ethernet Connection" option

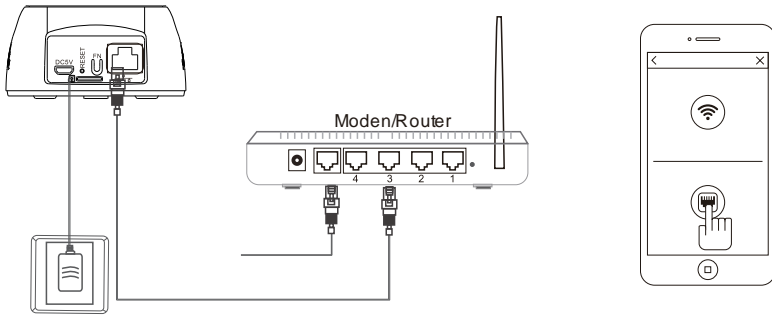

Method 2: Wi-Fi Connection

- Make sure you are in the same room as your wireless router and plug camera into power.

QR Code Method:

- Wait 1-2 min for camera boot up, scanning QR Code, watch for the WiFi indicator on the front of the camera to flash red and green alternating. Click the Wi-Fi connection icon, operate it under the APP instructions.

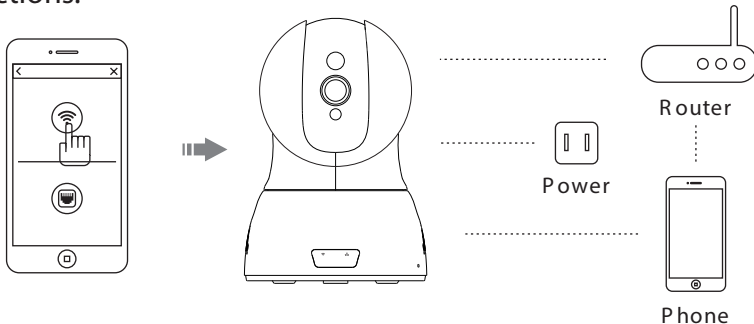

Web Access:

After setting up your camera on the mobile phone - you can use your account username and password to access the cameras from any device with an internet browser

Log on to the website:

<http://cloud.serenlifehome.com/>

Passwords

Should you happen to forget a camera's individual password you can reset it by performing a hardware reset. Just use a pin to press and hold the reset switch for 12 - 15 seconds. The camera will reboot and run through pan and tilt.

If you forget your account password you will need to register a new account and pair the cameras again.

Accounts are never associated with an email address for password recovery

Mobile App Layout

The main screen is your device list. You will see a thumbnail preview for all cameras added to your account.

Use this menu to

- Switch between different cameras
- Add new devices
- Access and change app global settings

App Settings

You can change your user admin and guest password and check the app software version.

Add Device

Add your cloud camera to your account through the icon.

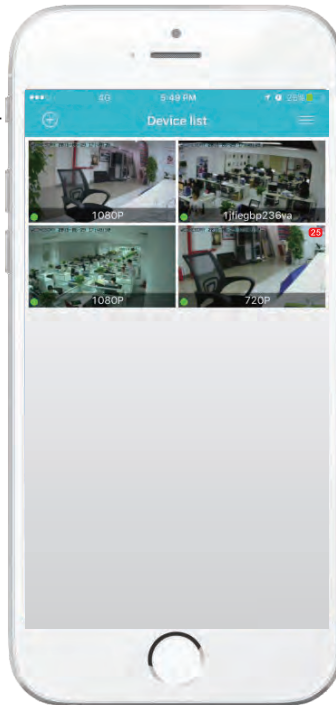

Alarm Messages

Shows which cameras have detected motion.

Camera View Page

This page give you access to all camera specific actions and settings

- Hold the phone vertically or horizontally to switch between full screen mode
- Swipe left and right on the video to reposition the camera
- Spread two fingers apart to zoom in

Sound

Activate to hear your cameras surroundings

Microphone

Activate to talk through your camera's speaker.

Snap Photo

Saves a photo to your phone's local memory

View the Video Records

and alarm messages
Click the icon to view the video recording and alarm message.

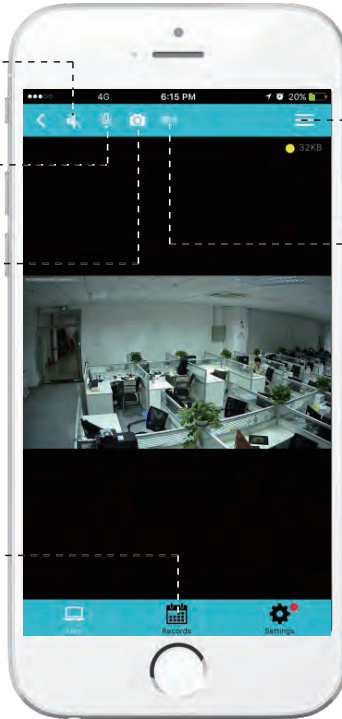

Image Settings

Set color, contrast, image res and more.

Local Video

Records the live video direct to phone memory. This feature only works while app is open. See "SD recording" for background recording options.

Camera Recordings

Enter into the interface of "information and video viewing" can see the alarm information and video of storage device (Micro SD or cloud box), users can quickly search the information and video by choose the time or category.

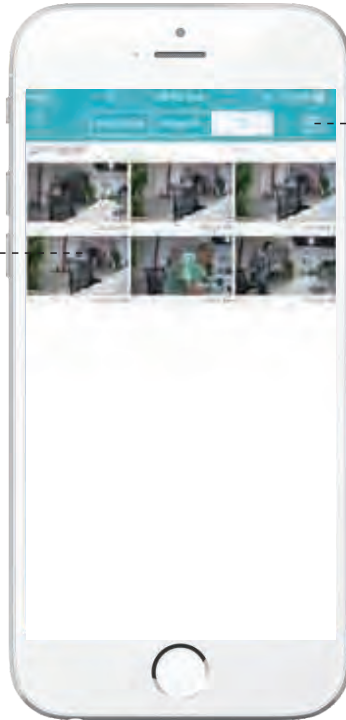

Records

Shows photos and videos stored on the SD memory card. Drag the screen down to load.

Local
Shows photos and videos recorded to the phone memory

Calendar Icon
Skip to a specific date and time..

Device Settings

This screen allows you to check and set camera specific settings.

If you see the red dot icon - a firmware update is available. Install available firmware updates to ensure the camera features are working as intended.

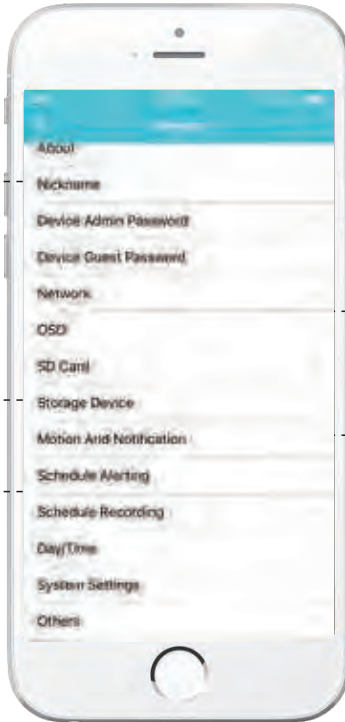

About

Check the camera's software version and ID number.

Storage Device

Connecting Cloud Box for storage

Schedule Recording

Set the recording schedule start and end time.

Network

Can set up the camera Wi-Fi connection

Motion and Notification

Set the motion detection alarm.

Recording Your Camera

You can choose 3 options for storing recordings for your camera

1) Local storage

This is the most simple method - just point and shoot. This only works while The phone app is open and running and will take up memory on your phone.

2) SD storage

Install an SD card and open up a world of possibilities!

Choose between scheduled recording, motion detection triggered recording or just let it run! The oldest videos will be overwritten to make room for the newest. You can download and save the videos from the mobile or website.

3) CloudBox storage

Sometimes SD storage just doesn't cut it. With a limit of 32g and the fact that the videos are stored directly in the camera - many people prefer the peace of mind the CloudBox can bring. Purchase the cloud box and back up 2TB of video storage from any device on a single network and check the videos from the same login. Find the CloudBox for sale on Amazon now!

Search "[SereneLife CloudBox](#)"

Motion Detection and Notification Settings Explained

You can set notification settings separately for any camera in your account. To access the notification settings, select your camera, and go to the settings tap - then scroll down to "**motion detection**"

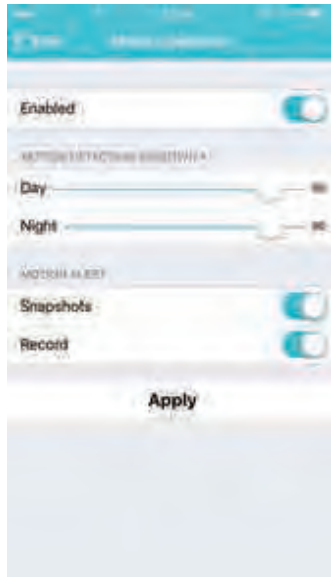

Slide the slider to enable motion detection

You can then choose what actions you would like to occur when your camera detects motion. Record will record video to the SD card while the camera detects motion.

You can also turn push notifications on and off by selecting "turn alert on" or "turn alert off".

If you are finding your camera is alerting you needlessly or failing to alert you if someone is moving, you can adjust the sensitivity for motion detection for the camera.

Go to "settings" > "**Motion Sensitivity**" and adjust the sliders for day and night separately

How to Improve Playback Performance

Choppy video?

Try the following to ease up the demands for data on your camera...

Decrease the Video Stream Quality

You can drop the resolution setting for the camera to make it easier on your home network's bandwidth.

Just open up the setting here and adjust until you get the desired performance level.

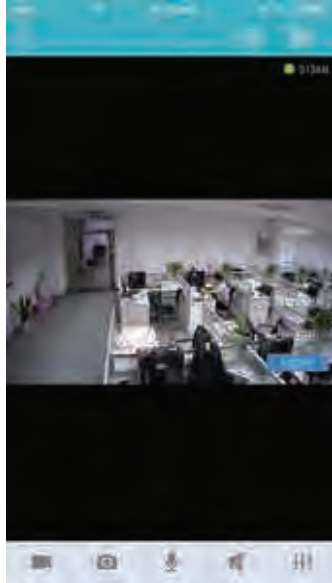

Plug your camera into a wired data connection

Do some tests before throwing in the towel for using the camera wirelessly

But the facts remain - wires are still quicker...

How to evaluate your home wireless network

Evaluate your wireless network

Cameras having trouble with wireless? You may want to consider upgrading your wireless network.

Lets do a basic evaluation of your home wireless network.

First, we recommend comparing your network speed with your wireless speed.

1. Run a speedtest from a laptop or desktop connected to your router with a wired connection. <http://www.speedtest.net/>
2. Compare this value to your wireless network apps like “Speed Test” to see if you have enough available data in the area you would like to set the camera.
3. Test your network range
 - What is your download speed in the same room as your wireless router?
 - What is the download speed in the location you are trying to install the camera?
 - Is there a significant drop?

What to upgrade?

1. If your wired connection is too slow to reach the bandwidth requirements of the camera you may need to consider upgrading your internet service.
2. If you have a significant drop in data when testing a wireless connection in the same room as your router, you may want to consider upgrading to a router that can provide higher data transmission speeds
3. If you see a significant drop in data when testing in the area you want to install your camera you can either look for an upgraded router that will offer additional range or you can expand your router range with a signal booster.

How to check and install firmware updates

Firmware updates ensure our new features will work 100% for your camera. It is a good idea to install them when you see they are available.

It is recommended that you install updates while on a wired connection to your router.

This will ensure loss of bandwidth is not an issue during updates

To check and install firmware updates

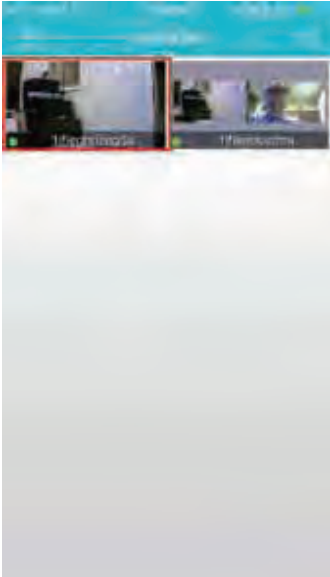

1. Tap the device preview image



2. Look for red dot indicating firmware update available - then enter settings



3. Scroll down to "System Settings" 4. Select Upgrade - then confirm

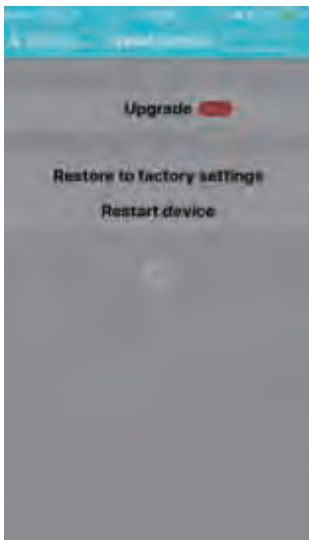

5. Now wait for the upgrade to proceed
- It can take 5 - 10 minutes
 - Do not quit the app or modify the camera hardware

6. Once complete - the app will tell you to restart the camera
 - However it should automatically restart itself
 - Wait 2-3 minutes for the camera to restart before checking the camera feed or settings
7. Check if any additional updates are available
 - Sometimes there will be multiple updates available in a row. Repeat the process until no new updates are available

Desktop access link: <http://cloud.serenelifehome.com/>

Other issues? Check our FAQ resources and contact support online!

www.SerenLifeHome.com

Compatible Products:

You can add any number of SereneLife cameras to your account with us to monitor multiple locations!



IPCAMHD12



IPCAMHD15



IPCAMHD61



IPCAMHD82

Troubleshooting

Can't connect to WiFi

- Connect the ethernet cable and check connection is working
- Go to "camera settings" > "network" Check the WiFi status is enabled and "List" displays your home network - doublecheck the password.
- In the Ethernet tab - disable the ethernet connection to force the camera to look for available WiFi network

Still having trouble?

- Try deleting the camera entry from your account
- Hardware reset the camera
- Add the camera as a new device

SD Card is not recognized by the camera

- Check the card is class 10 - 32g or less
- Insert the card while the camera is powered down then power up
- Try reformatting the card using your computer using "FAT32"
- Test multiple SD cards

App is crashing - a feature is not working

- Check for app updates
- Check for camera firmware updates
- Contact support with app version, mobile device model and OS version so we can update the app and fix the issue

Features:

- Full HD 1080p Video Camera Display Output
- Ability to Snap Pictures and Record Video
- Wi-Fi Wireless Network Connectivity
- Connect with Your Smartphone, Tablet, Laptop, Computer, etc.
- Monitor the Location Remotely and Control Via "SereneViewer" App
- Built-In Microphone and Speaker for 2-Way Communication
- Audio Record Schedule Timer: Video Recording While Away
- Can be Hard-Wired & Mounted, LAN (Ethernet Cable)
- Mountable for Safety/ Security Surveillance
- Micro SD Memory Card Reader
- Night Vision LED Illumination Lights
- Motion Detector Recording Mode
- Real-Time App Push Notification Alerts
- P2P Technology: Plug and Play Setup
- Image Adjustments Configuration Option
- Lightweight and Compact Design

- LED Indicator Status Lights
- Perfect at Home or in the Office
- Works for PC and Mac

The “SereneViewer” App:

- Free to Download & Easy-to-Use
- Gives you Remote Access to Live or Recorded Video
- Works with All of Today’s Latest Smartphones & Tablets
- Camera Management: Control, View & Add Additional Cameras
- Scheduled Recording: Set the Timer for Automatic Start Times
- Configurable Picture Adjustment Settings

Technical Specs:

- Imaging Sensor: 1/4” Color CMOS
- Video Resolution: 1080p (1920 x 1080 Pixels @ 30 FPS)
- Video File Format MJPEG, H.264
- Night Vision Distance 32” + ft. (0.01 LUX)
- Wi-Fi Wireless Network: IEEE802.11b/g/n
- Protocols: TCP/IP, UDP/IP, HTTP, DHCP, RTMP, MUDP
- Ethernet Network: 10/100Mbps, RJ-45 Interface
- P2P Technology Plug and Play
- Dynamic Code Rate Filtering Jitter Buffer
- Maximum Micro SD Card Support Size: 64GB
- Lighting Frequency: 50/60Hz
- Video Compression: H.264
- Audio Compression: AAC (Advance Audio Coding)
- Power Supply: DC 5V, 2 A
- Dimensions (L x W x H): 3.3” x 3.3” x 4.7”
- Sold as: 1

SereneLife



VISIT US ONLINE:

Have a question?

Need service or repair?

Want to leave a comment?

PyleUSA.com/ContactUs

PYLE