



PYLE

PyleUSA.com



PBKSRB40

Desktop Wireless BT Bookshelf Speakers

HiFi Studio Monitor Computer Desk Stereo Speaker System,
Connections and Studio Quality Sound,
Modern Stylish Quality Wood (60Watt MAX)

USER GUIDE



Please read all instructions before use for the best performance of this product. Save these instructions for future reference.

Box Contents

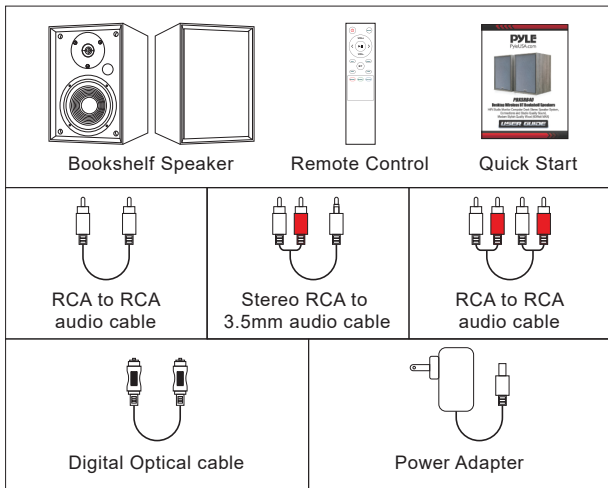

LED Indicators and Button Introduction

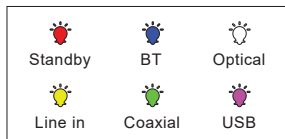
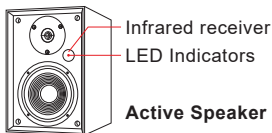

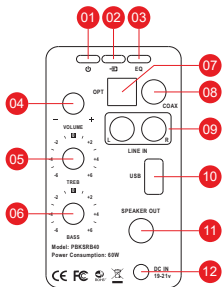

Active Speaker

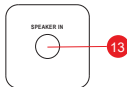

Passive Speaker

01. Power switch

02. Input selection

Press in to navigate between audio sources:
BT -> Optical -> Coaxial -> LINE IN -> USB

03. Sound effects

Press in to navigate between audio sources:
Music -> Dialogue -> Movie

04. Volume control

05. Treble control

06. Bass control

07. Optical input port

08. Coaxial input port

09. Line in input port

10. USB input port

11. Left speaker audio output

12. Power port

13. Left speaker audio in

Know Your Remote



	Power button		Mute/Unmute
	Volume up		Volume down
	Previous track		Next track
	Play/pause		Optical mode
	Coaxial mode		BT mode
	USB mode		Line mode
	Movie mode		Music mode
	Dialogue mode		

Connection Diagram

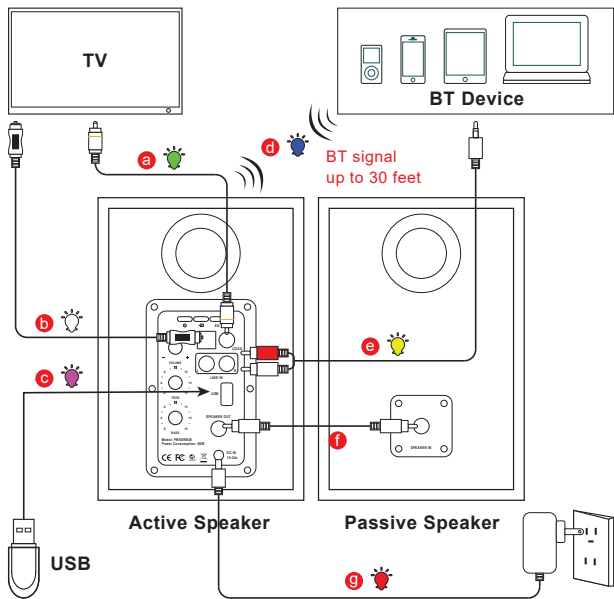

- a** Coaxial cable (not supplied)
- b** Digital Optical cable (supplied)
- c** USB (not supplied)
- d** BT
- e** Stereo RCA to 3.5mm audio cable (supplied)
- f** RCA to RCA audio cable (supplied)
- g** Power Adapter (supplied)

Connecting with a TV

Active Speaker

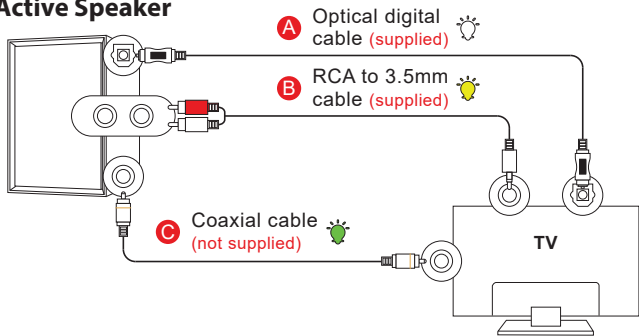

- A Method 1.** Connecting using an Optical cable.
Select Optical mode and set the TV's audio output to "PCM".
(More information on PCM page)
- B Method 2.** Connecting using a RCA to 3.5mm cable.
Select RCA mode.
- C Method 3.** Connecting using an Coaxial cable.
Select Coaxial mode and set the TV's audio output to "PCM".
(More information on PCM page)

Setting "PCM" on your TV

When all cables are connected properly, and LED indicator lights properly, if there is no sound from tv or Soundbar, please set your tv as below:

1. Press "**Menu**" on the TV's remote control.
2. Press the arrow keys on the remote to scroll to "**Audio Settings**."
3. Press "**OK**" on the remote control.
4. Scroll to "**Advanced Audio**" and press "**OK**". Some televisions may not have an "**Advanced Audio**" menu and may list various audio settings instead.
5. Scroll to "**Audio Output Mode**" or "**Digital Audio Output Mode**" and press "**OK**".
6. Scroll until "**PCM**" is displayed as the current audio output.
7. Press "**OK**" to save the settings.

Connecting a Wireless BT Device

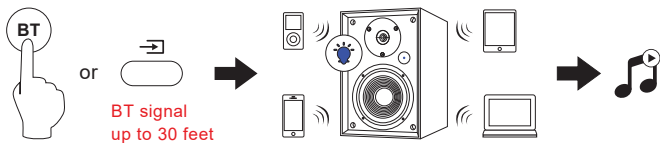

- a. Press the "**BT**" button on the remote or press the "**→**" button on back panel of the active speaker, the LED indicator blinks blue.
- b. Turn on Wireless BT on the BT device.
- c. Select "**PyleUSA**" and connect it. When your BT device is connected, the LED indicator blinks blue slowly.
- d. Play music files from the device, connected via BT, through the bookshelf speaker.

Troubleshooting

No sound

- Check if the power indicator light is ON.
- Try to turn up the volume using either the master volume control or remote control.
- Ensure the audio cables are firmly connected and the input is set correctly on the speakers.
- Check if there is signal output from the audio source.

Cannot connect via Wireless BT

- Make sure the speaker is switched to BT input, in other audio input mode BT can not be paired or connected. Disconnect from any BT device by press and hold the volume dial in BT mode, then try again.
- Effective BT transmission range is 10 meters, make sure operation is within the range.
- Try another BT device for connection.

The **PBKSRB40** Bookshelf Speaker does not turn on

Check if mains power is connected or if the wall outlet is switched on.

Specifications

Power output:	L/R: 30W + 30W
Signal to noise ratio dB(A):	L/R: ≥ 85 dB (A)
Input sensitivity:	LINE IN: R/L: 650 ± 50 mV
	Coaxial: R/L: 500 ± 50 mV
	OPT: R/L: 500 ± 50 mFFS
	BT: R/L: 700 ± 50 mFFS
Frequency response:	40HZ-18KHZ
Bass unit:	4 inch (116mm)
Tweeter unit:	$\Phi 13$ mm silk dome tweeter



PYLE
PyleUSA.com

Questions? Comments?

We are here to help!

Phone: (1) 718-535-1800

Email: support@pyleusa.com

