



PDIC63T

6.5" In-Wall / In-Ceiling 70V Speaker

Flush Mount Low-Profile Speaker
with 70 Volt Transformer (500 Watt)

PDIC63T SPL

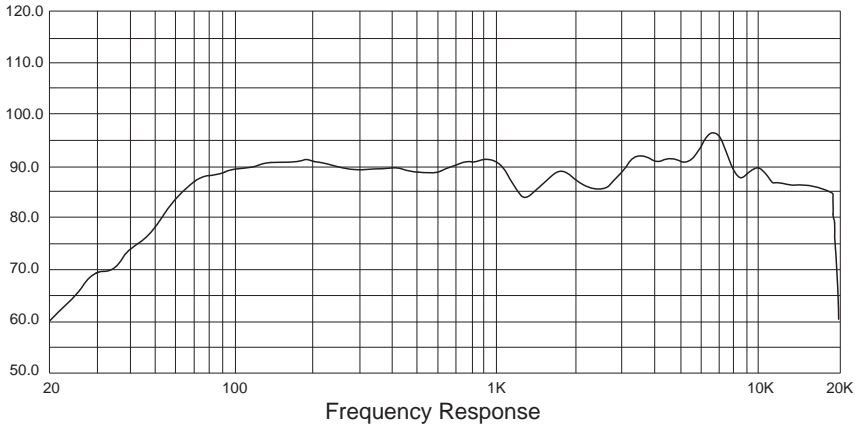

PDIC63T IMP

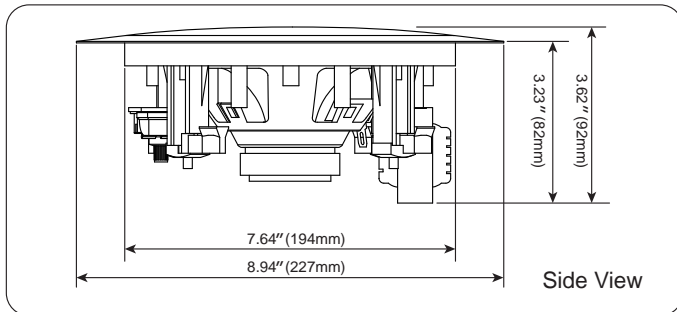
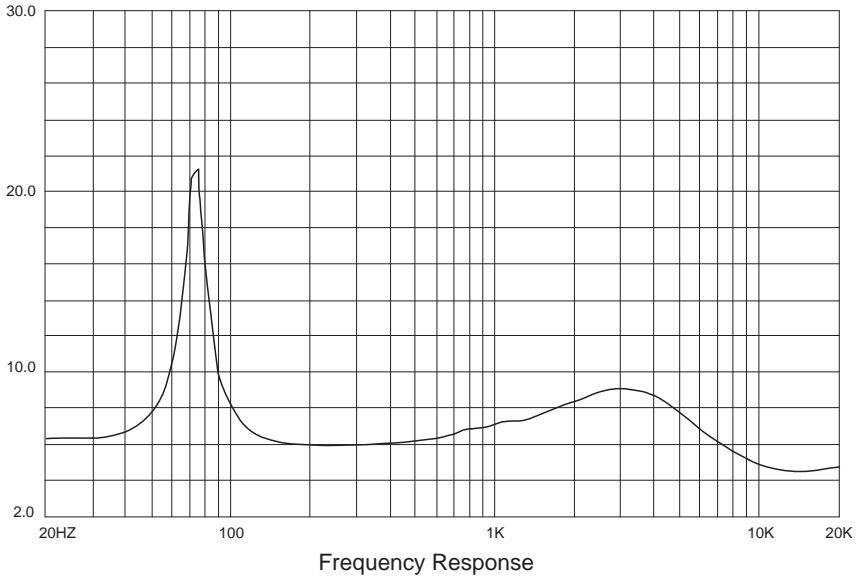

• Speaker Installation

1

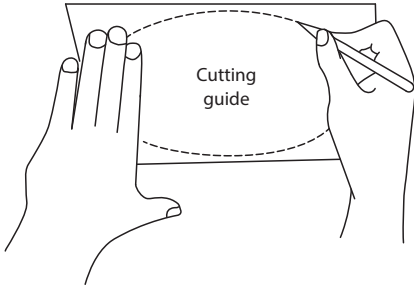

2

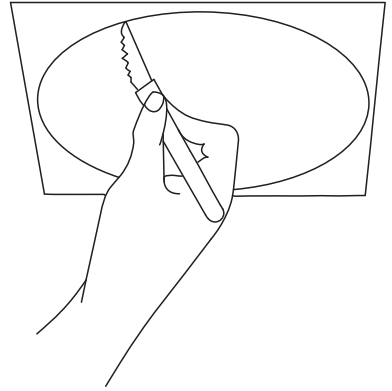

3

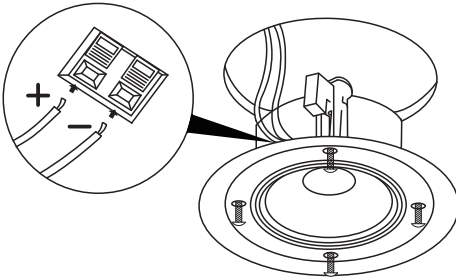

4

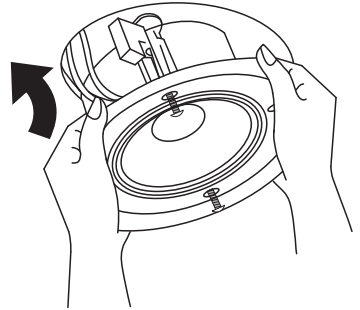

5

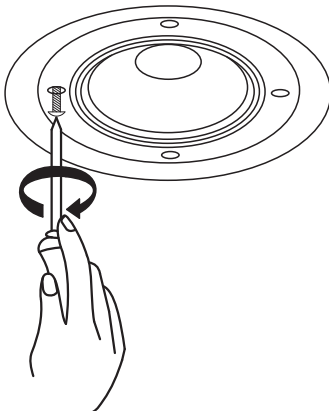

6

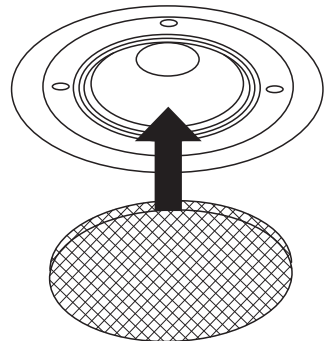

- 1.** Position the cutting guide against the required speaker placement and trace around.
- 2.** Cut out the traced area using a pad saw or other suitable tool.
- 3.** Take the speaker unit out of the packaging and remove the grille. Connect the speaker wire to the appropriate “+” and “-” connections (select the desired tapping for 70V device).
- 4.** Locate the speaker unit into the cut-out, ensuring that the 4 rotating fixing clamps stay turned inward.
- 5.** Once located, turning the 4 fixing screws clockwise will cause the fixing clamps to rotate outward and tighten onto the mounting surface.
- 6.** Push the speaker grille into place by applying even pressure around the rim.

PDIC63T

6.5" In-Wall / In-Ceiling 70V Speaker

Flush Mount Low-Profile Speaker
with 70 Volt Transformer (500 Watt)

Features:

- In-Wall / In-Ceiling Speaker System
- Built-in 70 Volt Transformer Tapping
- Flush Mount, Slim Low-Profile Design
- 2-Way Full Range Stereo Sound
- High-Impedance, Line-Matching Transformer
- Used for Amplifier / PA Speaker Public Address Systems
- Mounts Flush on Walls or Ceilings
- 1/2" High Compliance Dome Tweeter
- Poly Mica Cone with High-Sensitivity Foam Edge
- Cut-Out Size Template for Easy Installation
- Environmentally Friendly ABS Construction
- Used for Home, Office & Business Applications

Technical Specs:

- Power Output: 500 Watt MAX
- Speaker Size: 6.5" -inches
- 70V Transformer Tapping at 20W/15W/10W/5W/2.5W and 8OHM
- Impedance: 8 Ohm
- Frequency Response: 75Hz-20kHz
- Sensitivity: 89 dB
- Magnet: 16 oz.
- Cut-Out Diameter: 7.64" -inches
- Mounting Depth: 3.23" -inches
- Total Speaker Size (Diameter x Depth): 8.94" x 3.62" -inches
- Sold as: 1

PYLE

PyleUSA.com



VISIT US ONLINE:

Have a question?

Need service or repair?

Want to leave a comment?

PyleUSA.com/ContactUs

PYLE