

PYLE
PyleUSA.com



VISIT US ONLINE:
Have a question?
Need service or repair?
Want to leave a comment?
PyleUSA.com/ContactUs

PYLE



PDWM1950

PDWM1958B

PDWM2850



PDWM2880B

PDWM1980



PDWM1988B

PDWM2950



PDWM2958B

Compact UHF Wireless Microphone System
USB Powered Desktop Mic Receiver System
with Adjustable Volume Control

USER MANUAL

- To set up the system and to avoid interference, each unit may have many presented channels.
- When using numbers of receivers/transmitters together, each unit should use different channels.

Tips

1. Transmitter and antenna should keep in a barrier-free linear relative position.
2. Do not place receiver close to metal surface object or digital equipment.
3. Try to keep receiver 1.5m above the floor and 1m away from the wall.

Contents

System Component 1

Receiver 2-3

Body Pack Transmitter 4-6

Body Pack Transmitter Connection 7

Charging the Microphone 8

Configuration of Multiple Systems 8

Troubleshooting 9

Specification 11

System Component

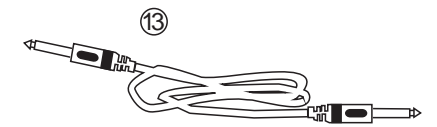
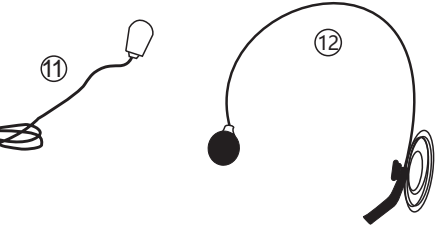
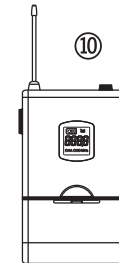
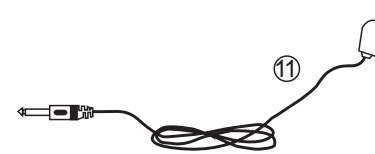
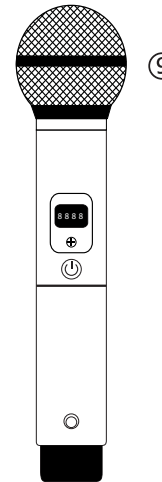
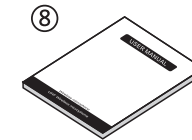
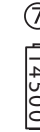
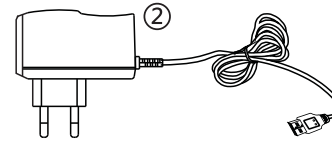
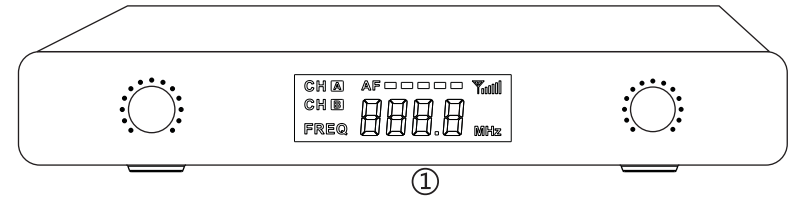

1. Wireless receiver
2. Adapter (optional)
3. Adapter (optional)
4. Cable (optional)
5. Charging cable(optional)
6. AA batteries (optional)
7. 14500 lithium battery (optional)
8. User manual (Optional)
9. Handheld transmitter (optional)
10. Body pack transmitter (optional)
11. Lavalier microphone (optional)
12. Headset mic (optional)
13. 6.35" signal output cable

The contents above are for the whole system, the actual component may differ

Receiver

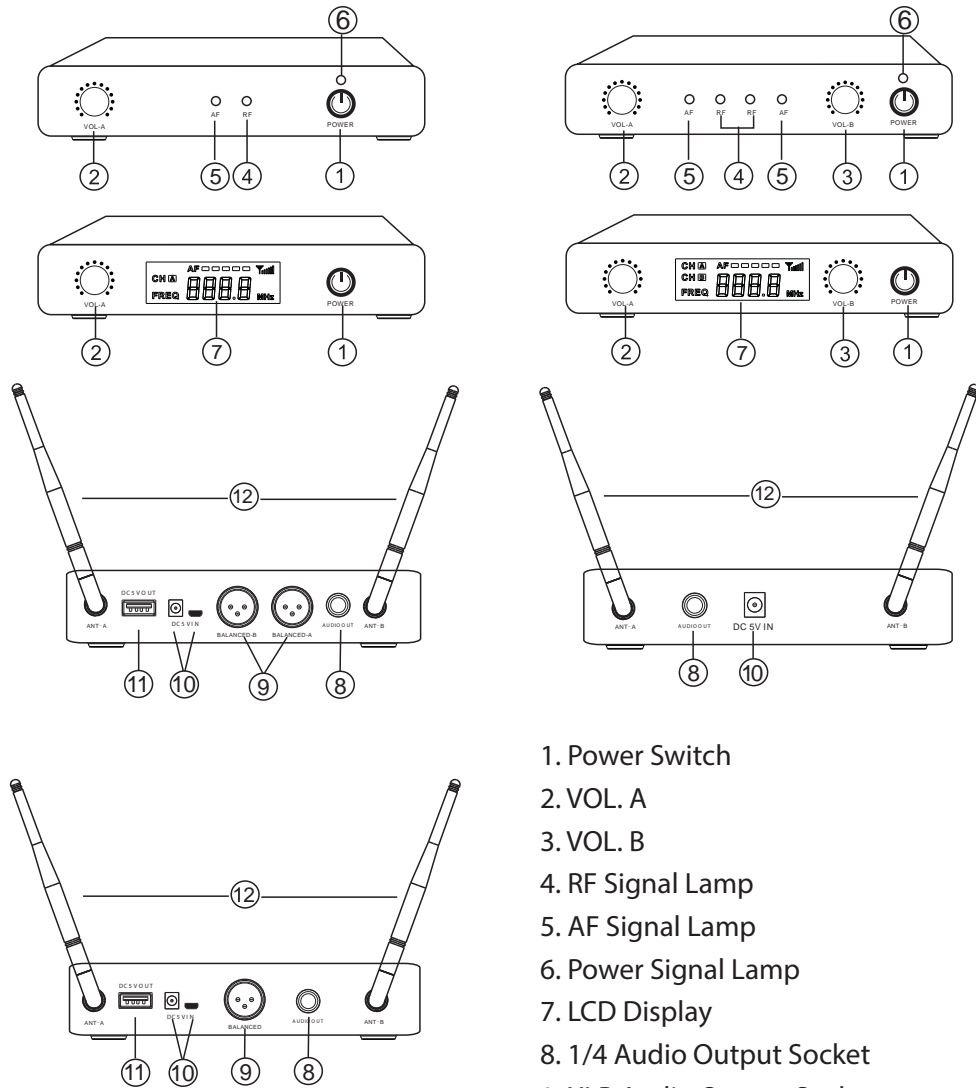

1. Power Switch
2. VOL. A
3. VOL. B
4. RF Signal Lamp
5. AF Signal Lamp
6. Power Signal Lamp
7. LCD Display
8. 1/4 Audio Output Socket
9. XLR Audio Output Socket
10. Power Input Socket
11. Charging Socket
12. ANT-A

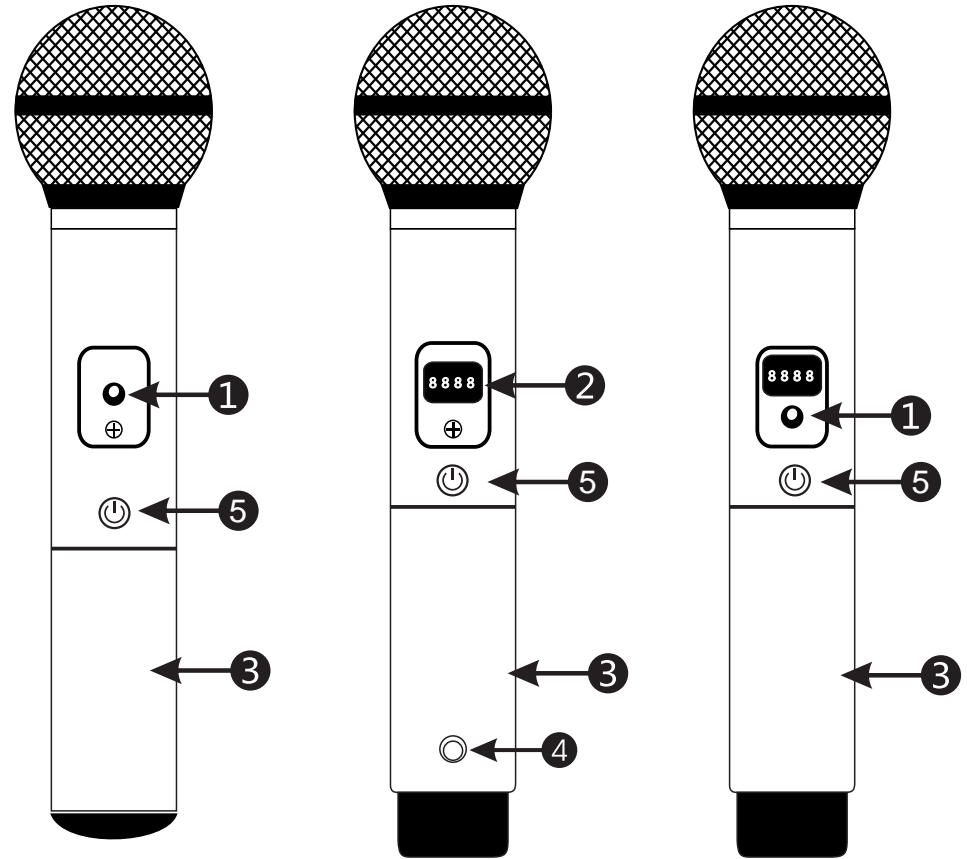

1. Power signal lamp
2. LED display
3. Battery Cover
4. Frequency-change button
5. Power switch

The images above are indicative only, the actual product may differ

Body Pack Transmitter (Only apply to some models)

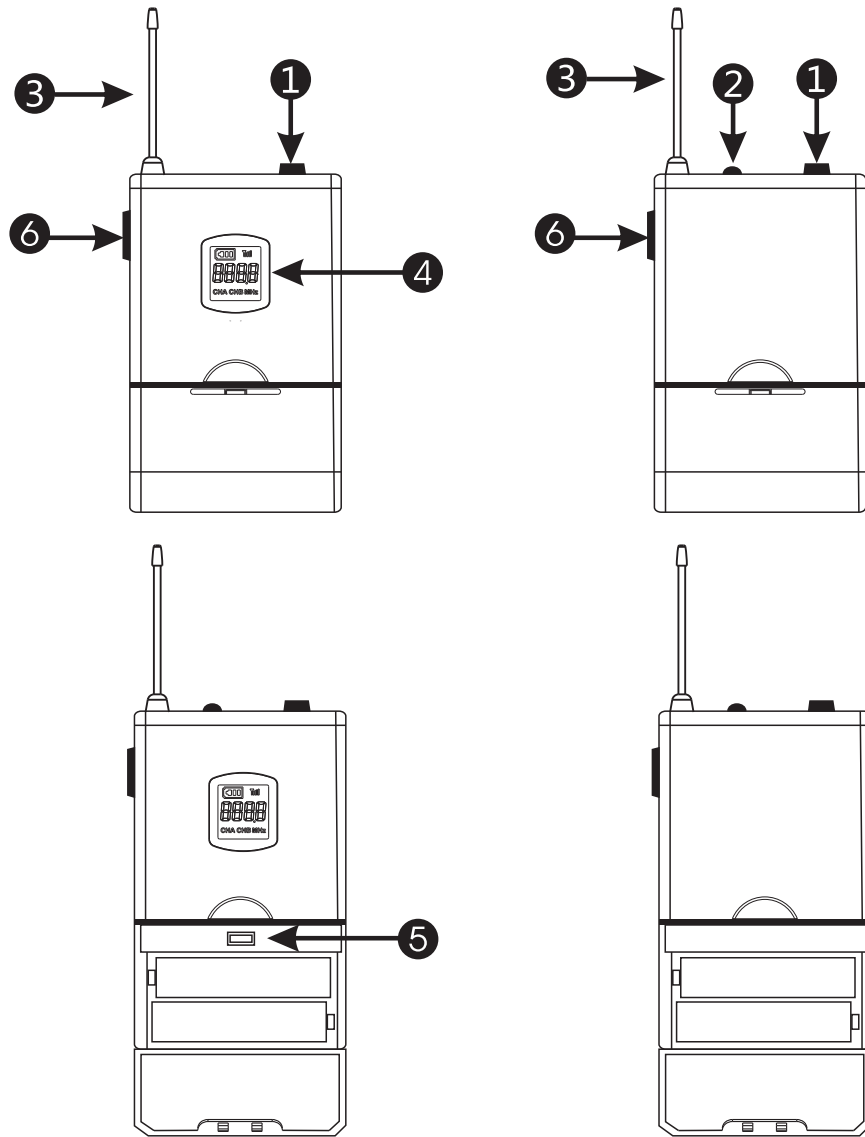

Functions

- | | |
|---------------------------|----------------------------|
| 1. Clip microphone socket | 4. LED display |
| 2. LED light | 5. Frequency-change button |
| 3. Antenna | 6. Power switch |

Matching Receiver and Transmitter (Only apply to some models)

1. Make sure the receiver is powered **OFF**.
2. On transmitter side, press and hold the frequency-change button, then press and hold the power button till the display is flashing.
3. Turn **ON** the receiver and then you will see the RF light is flashing.
4. **Attention:** For the receiver that has LED display, turn **ON** the receiver and wait for 3-5 seconds
5. Get back to the transmitter side and re-press the frequency-change button.
6. Matching is successful if the RF light is **ON** or the LED display shows frequency, otherwise, re-do step 1 to step 5.

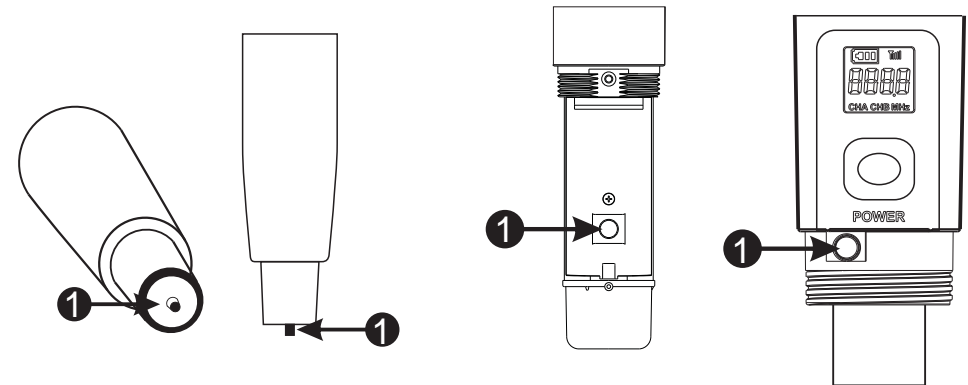

① Frequency-change button

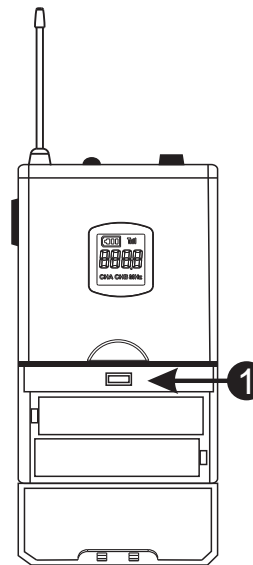

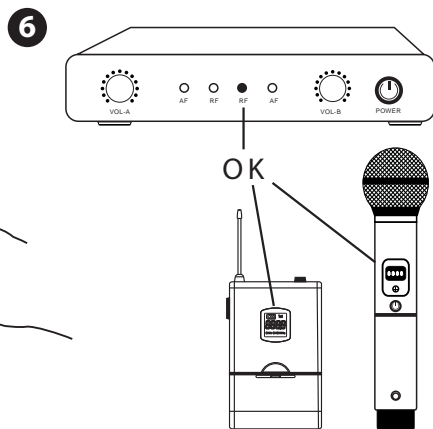
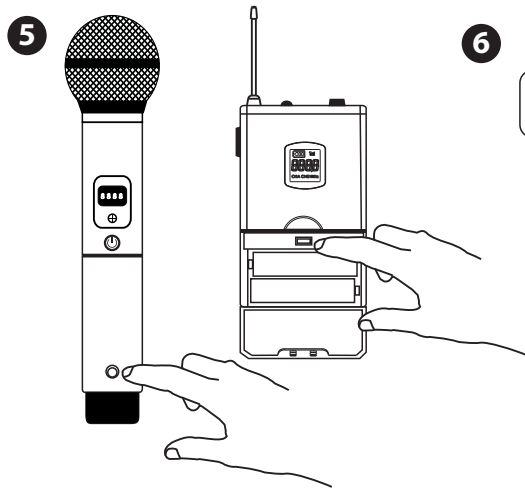
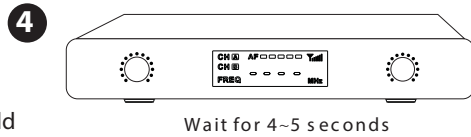
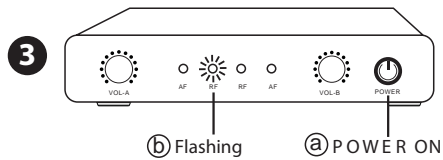
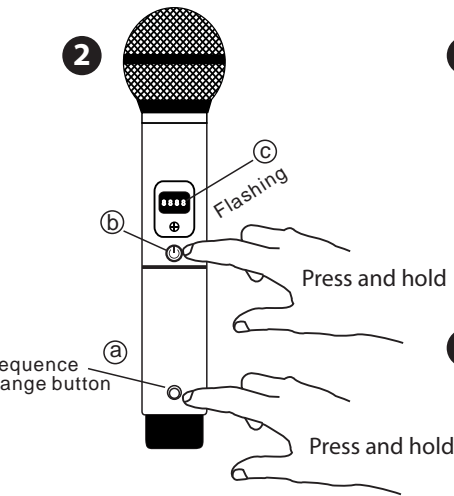
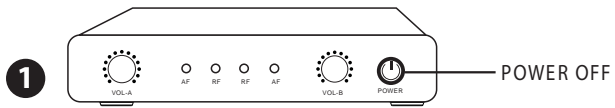

BODYPACK TRANSMITTER CONNECTION

1. Lavalier Microphone Connection:

Connect the connector of supplied lavalier microphone to the connecting jack of transmitter (Shown as below). Set the transmitter work state in wireless lavalier system.

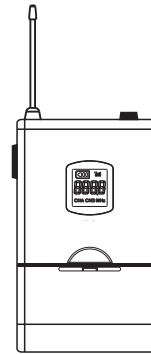

A

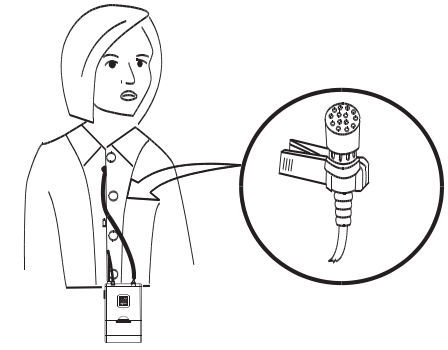

B

2. Headset Microphone Connection:

Connect the connector of supplied headset microphone to the connecting jack of transmitter (Shown as below). Set the transmitter work state in wireless headset system.

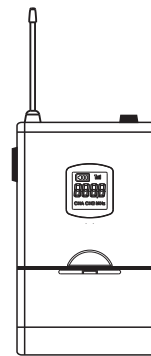

A



B

Charging the microphone (Only apply to some models)

CAUTION: For charging microphone, **MUST NOT** use AA battery to power the microphone. **MUST** use 14500 lithium battery.

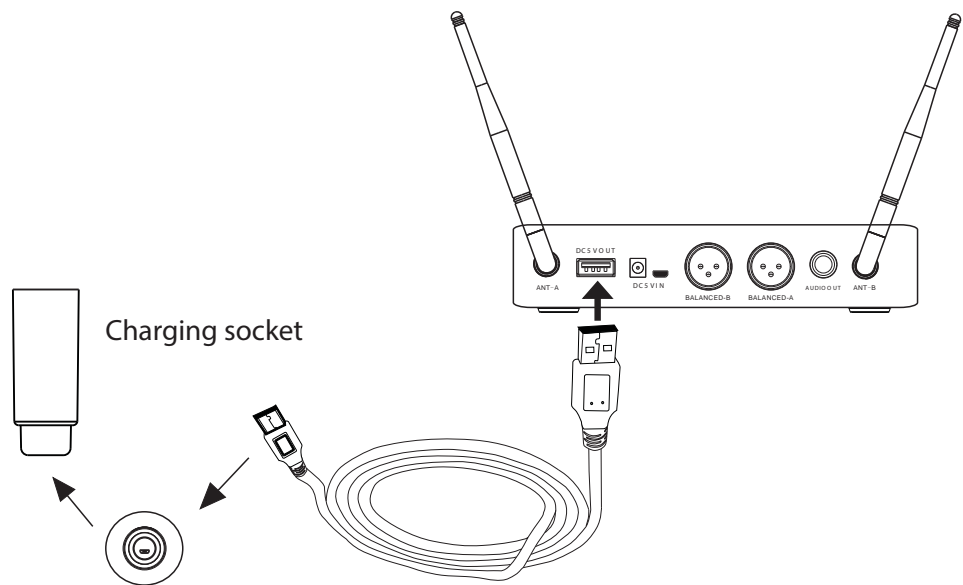

Configuration of Multiple Systems

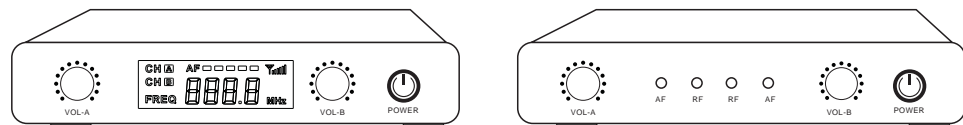

1. Transmitters match corresponding receivers to prevent frequency interference
(See "Matching receiver and transmitter" for reference)
2. Using different frequencies among transmitters
(The difference should be 3-4MHz for each transmitters)

TROUBLESHOOTING

Problem	Status	Solution
No sound or sound is weak	Transmitter display or light is off	<ol style="list-style-type: none"> 1. Turn on transmitter 2. Make sure battery is installed right 3. Replace batteries
	Receiver display or light is off	Make sure adapter is plugged into receiver DC socket, and the adapter is power supplied
	Receiver display or light indicate RF signal	<ol style="list-style-type: none"> 1. Turn up receiver volume 2. Check the cable connection of receiver
	Receiver display or light indicate no RF signal; Transmitter and receiver power light is on	<ol style="list-style-type: none"> 1. Remove receiver away from metal objects 2. Check if barrier is between receiver and transmitter 3. See "Matching receiver and transmitter"
Distortion or unwanted noise bursts	Receiver display or light indicate RF signal	<ol style="list-style-type: none"> 1. Remove interference sources nearby 2. Change receiver and transmitter working frequency 3. Replace transmitter batteries 4. If using many sets together, increase working frequency interval of systems 5. Maximize the volume button
Failed to turn ON transmitter	Press power button, transmitter not working, or shut down after a second	<ol style="list-style-type: none"> 1. Replace batteries 2. Re-press power button after few seconds

DESKTOP WIRELESS MICROPHONE SYSTEM



PDWM1950



PDWM1958B



PDWM2850



PDWM2880B



PDWM1980



PDWM1988B



PDWM2950



PDWM2958B

SPECIFICATION

Some specification may not apply to some models.

RECEIVER

Channels	-----	16 Channels
SNR	-----	96db
Sensitivity	-----	96dbm
Frequency Response	-----	30~20kHz
Channel Interval	-----	500kHz
Output Impedance	-----	600 Ohm
Power Supply	-----	5V
Power Consumption	-----	<85Ma
LED Display		

HANDHELD TRANSMITTER

Power Output	-----	10dbm
Frequency Response	-----	30kHz~20kHz
Power Supply	-----	3v (Normal battery)
Power Supply	-----	3.7V (Lithium battery)

BODYPACK TRANSMITTER

Power Output	-----	10dbm
Frequency Response	-----	30kHz~20kHz
Power Supply	-----	3v