



PYLE® GUITAR

6-String Electric Acoustic Guitar

High-Quality Acoustic Guitar with Accessory Kit

USER GUIDE

Please take a few moments to read through this booklet.

In it you will find answers to many of your questions and other invaluable information about tuning and changing strings.

Protection from Temperature and Humidity

The most important thing you can do to ensure the structural integrity of your instrument over time, is to maintain the moisture content of the wood consistently at the appropriate level.

It is 100% certain that an acoustic guitar will be exposed to varied and multiple environmental/climatic conditions from the time it leaves the maker's hands until it reaches its ultimate owner. The environment where you live may be a complete polar opposite from that of the climate where the instrument was produced. It is of paramount importance to evaluate, measure and stabilize the moisture content in the wood as soon as possible after bringing an instrument into a new environment.

In the winter, the forced air systems used to heat most homes can drive temperatures up and humidity levels dangerously low for guitars. Extremely low levels of humidity will result in low moisture content in the wood and ultimately, damage to the guitar. A good measure of protection against drying out your guitar is to use a room humidifier to maintain the ideal relative humidity of between 40% and 50%.

When the instrument is not in use, we recommend that you keep it in its case with a hygrometer to monitor the humidity level. Do not leave the guitar out of the case for long periods near a heating vent, radiator or in direct sunlight near a window. Do not leave your guitar in the trunk or the cabin of a car for long periods and keep it away from excessive heat and cold.

Please Note: *Damage caused to the guitar as the result of exposure to variations in temperature and/or humidity will not be covered under the PyleUSA warranty.*

Tuning 6-string Guitars

Something as simple as how you wind the strings onto the tuning machine posts when changing your strings, will determine tuning stability and even string tension. It's also a good idea to stretch your strings just a little as you tune to make sure that each string is seated well and snugged down on the tuning machine post. This will save you some tuning frustration down the road. Just grab the string in the middle, lightly tug it up and down to remove slack, and then retune.

There are a couple of different methods for tuning a guitar, depending on whether your guitar is acoustic, or an acoustic with a pickup and onboard tuner. If your guitar does not have an onboard tuner and you don't own an electronic chromatic tuner with a reference tone, you may want to purchase one. It will dramatically simplify tuning your acoustic or electric guitar.

Always tune from below pitch, up to the correct pitch instead of down from a higher pitch. This will help eliminate string slack from the tuning machine and decrease the possibility of slippage and tuning changes as you play.

If using the onboard tuner on your guitar, simply plug in, activate the tuner, turn the volume up and starting from the thickest (bottom) string to the thinnest (top), tune the strings to: **E, A, D, G, B, E**.

If you do not have an onboard or an electronic tuner, use a guitar pitch pipe, an A-440 tuning fork or some other pitch reference, and begin by:

- Tuning the second string, "**A**" to pitch.
- Then, depress the second, or "**A**" string at the 5th fret, to produce a "**D**", and tune the "**D**" string to that same pitch.
- Next, depress the "**D**" string at the 5th fret, to produce a "**G**", and tune the "**G**" string until the pitches match.
- Next, depress the "**G**" string at the 4th fret, to produce a "**B**", and tune the "**B**" string until the pitches match.
- Next, depress the "**B**" string at the 5th fret, to produce an "**E**" and tune the thinnest string to a matching "**E**".
- Finally, go back and play the thickest "**E**" string and tune it until the pitch at the 5th fret, an "**A**", matches the "**A**" on the adjacent string.

Changing Strings

A fresh new set of strings can breathe renewed life into your instrument. That is why many “**tone-conscious**” touring professionals change their strings before every performance. While there is no set rule on how often to change strings, we have found that most players do not change them nearly as often as they should.

Body oils, acids and salts from sweaty hands and humidity all interact with the metals in guitar strings and cause a corrosion and breakdown of the materials. Don't wait until your strings break and fall off from old age before you change them. Worn, oxidized, pitted and dirty strings will not hold pitch, and simply sound bad. If you are an average player, playing several times a week, we suggest that you change the strings at least once a month.

When changing strings, we recommend that you remove and replace each string one at a time, instead of all at once. This will prevent sudden and potentially damaging changes in neck tension. Each new string should be tuned up to correct pitch before the next one is removed. When tuning a brand new string, always bring it up to pitch slowly. Otherwise, the rapid stretching may cause the string to break.

Re-Stringing Your Guitar

The procedure for re-stringing flat-top acoustic guitars and basses is quite similar in the way that the strings are wound onto the tuning machines.

There are differences though, in how the strings are attached to the bridges of acoustic flat-top and classical guitars.

Please Note: *When changing strings, change them one at a time. Do not remove all of the strings at the same time, as doing so will release all of the tension at once from the neck and body, which may potentially cause distortion and damage to the instrument.*

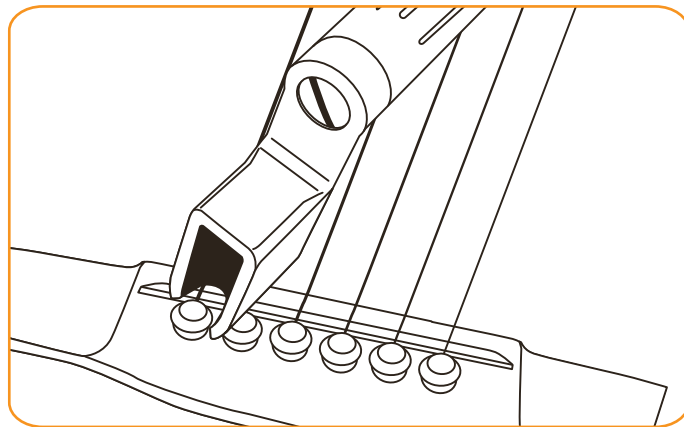

illustration 4

Stringing Flat-Top, Steel String Acoustic Guitars:

Flat-top acoustics have a surface mounted pin style bridge with holes and bridge pins to hold the strings in place. To re-string a flattop, remove the bridge pin and the old string. If the bridge pin is difficult to remove, you may want to purchase a combination string winder/bridge pin puller from your local Dealer, (**Figure 4**). Feed the ball end of the new string into the corresponding hole in the bridge, and then reinsert the bridge pin snugly to keep the string in place. Make sure that the bridge pin is positioned with the grooved side riding over the string, (**Figure 5**). Do not hammer the bridge pin in. A firm twisting push with the thumb should secure it in place.

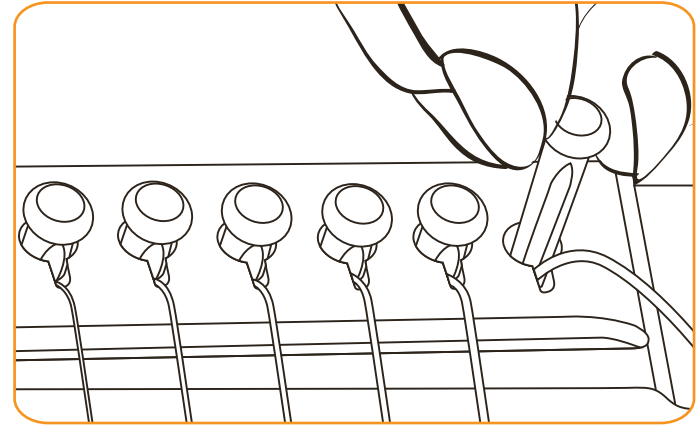

illustration 5

Next, pull the string up over the nut towards the headstock and bend it around the tuning machine post toward the tuning machine button, (**Figure 6**) Thread the string through the hole in the post and begin winding the button to remove the slack in the string. Continue winding to form a neat coil.

Finally, tune the string to the appropriate pitch. Pull up gently at the center point of the string to stretch it.

Retune, and repeat, until unwanted slack is eliminated and the tuning of the strings is stabilized this will prevent slipping and save you tuning frustrations down the road.

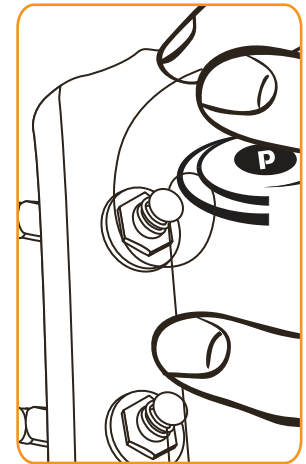
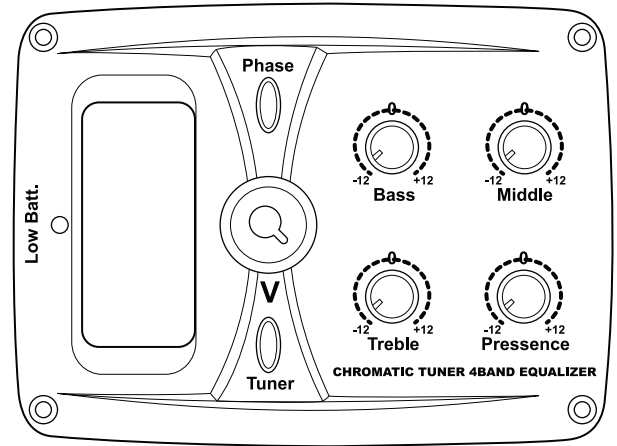

illustration 6

EQ Controls

Before you install batteries or plug your guitar into an amplifier, make sure that all volume knobs or are at zero.

1. **Plug in:** Connect to an amplifier with a instrument cable.
The batt light will flash once quickly to indicate it has switched on.
2. **Digital Tuner:** Press the tuner button and the guitar is muted and chromatic tuning is engaged, key clearly displayed on the LED screen. You may tune any string you like, and the tuner will pick up the signal and indicate if you are sharp or flat.
3. **Phase:** When the phase button is activated the guitar tone will produce more warmer sounds, e.g. more bass tones will come through, when switched off, the phase can cut bass response often helping avoid feedback in gig situations.
4. **BASS:** Controls the amount of bass frequency in the signal.
All the way left = no bass, all the way right = Lots of bass. Everything else in between!
5. **MIDDLE:** Controls the amount of mid frequencies in the signal.
6. **TREB:** Controls the amount of treble frequencies in the signal.
7. **PRESENCE:** Provides a little extra flavor to your signal- adjust to taste.
8. **V (Volume):** Controls your volume output.
8. **LOW BATTERY:** Turns ON when your battery is low.



**Be sure to unplug your cable when the instrument is not in use, as the battery will drain as long as a cable is plugged into the instrument.*

How to Adjust an Acoustic Guitar Truss Rod

Your truss rod needs adjustment when the neck of your guitar has too much or too little upbow or too much backbow. Tightening or loosening the adjustment nut adds or lessens pressure on the rod and neck. As a general rule, tightening the nut moves the neck away from the string pull and removes upbow; loosening the nut allows the neck to relax into an upbow again (especially when helped by the strings' pull). Controlled upbow is known as relief.

However, with a one-way truss rod, if the neck warps away from the string pull, no amount of loosening the truss rod will pull the neck straight, because the truss rod only works against the pull of the strings.

Two primary signs tell you that your truss rod needs adjusting:

1. There's a noticeable change in the action; the height of the strings over the frets has become either too high or too low. The most common scenario is that the strings get higher as the neck upbows from the string pull.
2. Some strings buzz on the frets between the nut and the fifth fret. This indicates that the neck is either too straight or it is backbowed from the truss rod's slow, constant pressure over time.

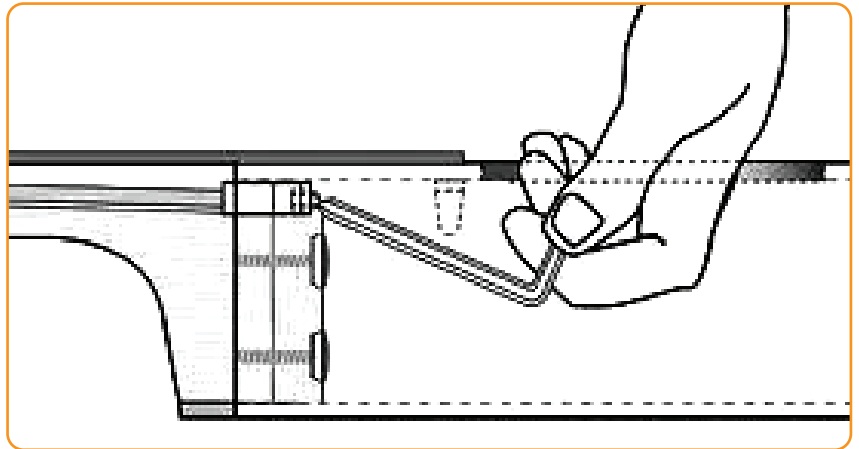

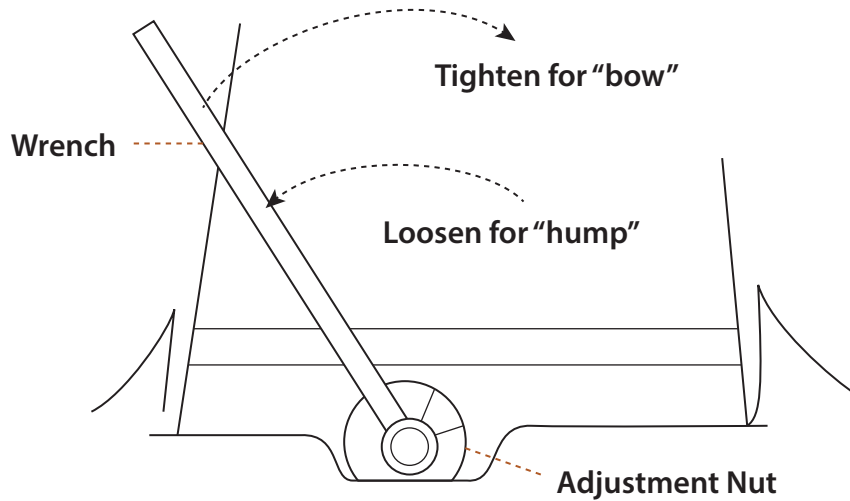

1. 1/4" nut
2. 3/16" washer
3. Threads
4. Main shaft of the truss rod
5. Truss rod anchor
6. Truss rod compartment cover
7. 1/4" nut driver

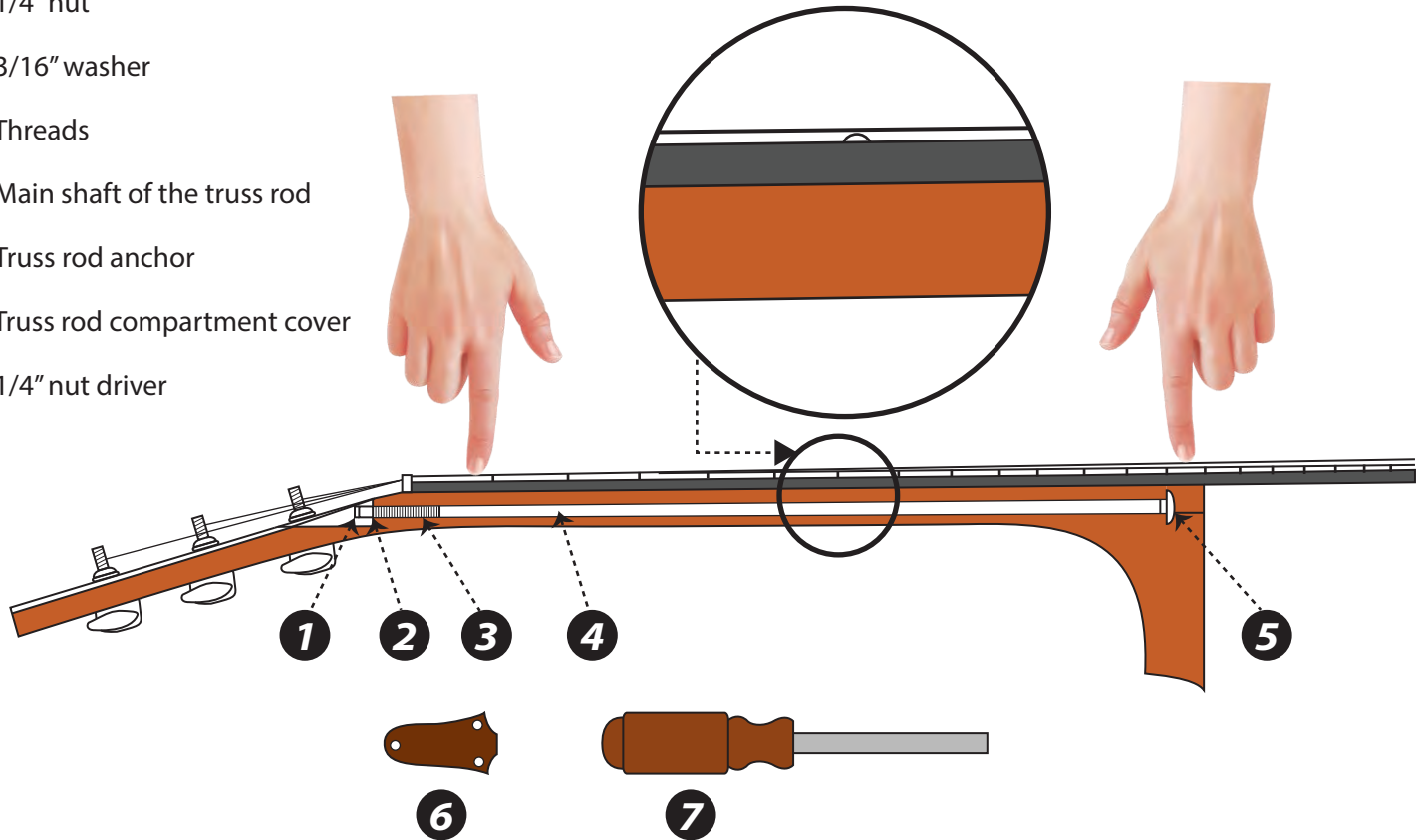

As you press the string down at the 1st and 14th frets, the string should be approximately .010" away from the 6th fret - about the thickness of a business card.



Questions? Issues?

We are here to help!

Phone: (1) 718-535-1800

Email: support@pyleusa.com