















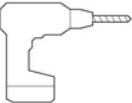

# INSTRUCTION'S MANUAL

# Assembly Instructions / Directives d'assemblage / Instrucciones

Qty Qté Cant	Parts List Liste des pièces Lista de Componentes	<b>Tools Needed</b> (not included) <b>Outils requis</b> (non fournis) <b>Herramientas Necesario</b> (no incluido)
2	 A	 (X) Phillips Screwdriver Tournevis à pointe plate Desarmador de cruz
2	 B	 (E) Flat Tip Screwdriver Tournevis à pointe cruciforme Desarmador plano
2	 C	<b>Optional Facultatif Optativo</b>
2	 D	 Power Drill Perceuse électrique Taladro eléctrico
4	 E	
4	 F	
2	 G	
2	 H	
2	 I-a	
2	 I-b	
8	 J	



1600 63rd Street  
Brooklyn, NY 11204  
(718) 535-1800  
(800) 44-5671  
FAX: (718) 236-2400  
[www.pyleaudio.com](http://www.pyleaudio.com)

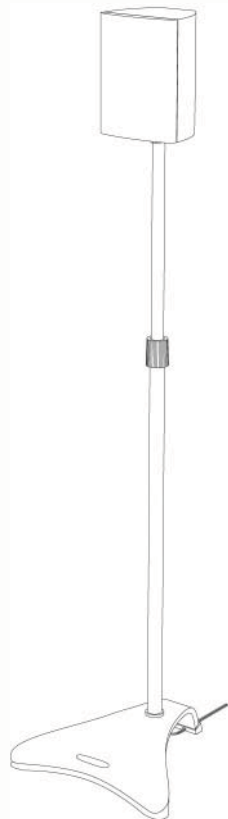

\* All Electronic Components and accessories are not included.  
\* No se incluye ningún componente electrónico ni accesorio  
\* Tous les composants électroniques et accessoires ne sont pas compris

①

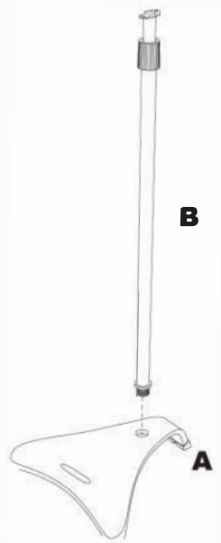

②

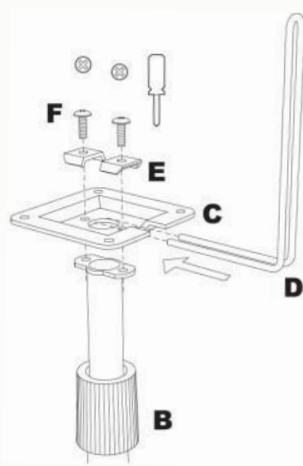

③

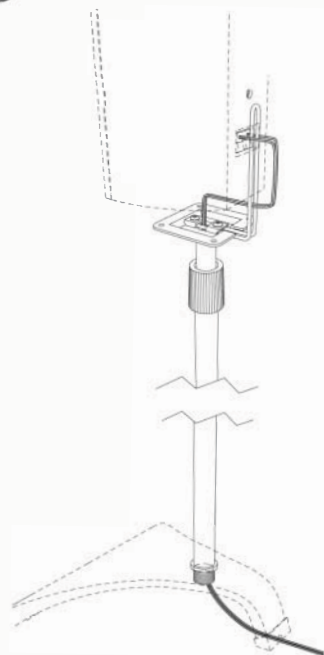

Speaker wire management  
 Manejo de alambre de bocina  
 Installation des fils de haut-parleurs

4 **Mounting Speakers / Montage de haut-parleurs / Montaje de las bocinas:**

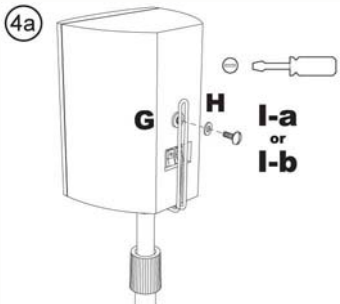

OR \* OU \* O

If speaker has the built-in mounting screw, then use (G), (H) and (I-a) or (I-b) for various speakers.

Si le haut-parleur possède une vis de montage intégrée, utilisez alors (G), (H) et (I-a) ou (I-b) en fonction des vos haut-parleurs.

Si la bocina cuenta con un tornillo integrado, use entonces (G), (H) y (I-a) o (I-b), dependiendo del que le quede a sus bocinas

OR \* OU \* O

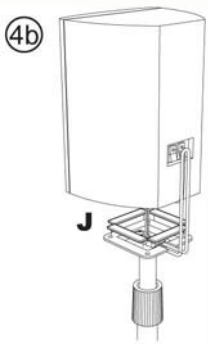

Use the double-sided tape (J). Peel backing to expose adhesive and mount on item (C).

Utilisez le ruban adhésif de montage (J). Pelez le papier à l'endos pour exposer la partie adhésive et montez sur la pièce (C).

Use la cinta adhesiva por los dos lados (J). Remueva la cubierta trasera para revelar el adhesivo y montar en el componente (C).

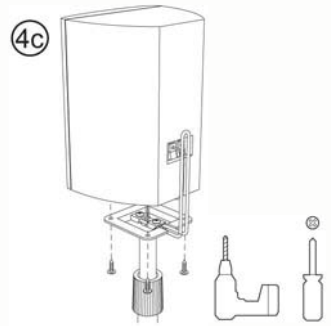

Screw mount directly to the speaker. Mark holes on bottom of speaker and drill holes. Screw speaker onto speaker stand. (Wood screws NOT provided)

Vissez au haut-parleur. Marquez l'endroit où percer les trous dans le bas du haut-parleur et percez les trous. Vissez le haut-parleur dans le support du haut-parleur. (Vis à bois NON fournies).

Atornille directamente a la bocina. Marque las perforaciones en la base de la bocina y taladre. Atornille la bocina al soporte para bocinas. (Los tornillos para madera no están incluidos).

5

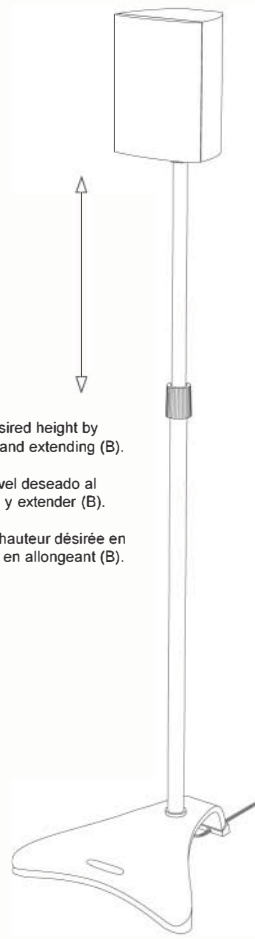

Adjust to desired height by unscrewing and extending (B).

Ajustar al nivel deseado al desatornillar y extender (B).

Ajuster à la hauteur désirée en dévissant et en allongeant (B).

**PLYLE PRO**  
 1600 63rd Street  
 Brooklyn, NY 11204  
 (718) 535-1800  
 (800) 44-5671  
 FAX: (718) 236-2400  
[www.pyleaudio.com](http://www.pyleaudio.com)