

Visit us @ pyleaudio.com

PYLE[®]
view



PL73D

Adjustable Headrests w/ Built-In 7-Inch TFT/LCD Monitor w/ Built in DVD Player & IR/FM Transmitter
w/Zipper Hide-Away Cover / Built In Game With Joystick

Owner's Manual

Contents

A. Precautions	01	N. Function of keys	12
B. Notice before operation . .	02	POWER	12
C. Accessories	03	Cover opening	12
D. Features	04	PLAY/PAUSE	12
E. Video disk type	04	Fast forward/fast backward	12
F. System connection and installation	05	PREV/NEXT	12
G. Key parts in front of the player	06	STOP/RETURN	12
H. Key parts at back of the player	07	SLOW	13
I. Battery installation for remote controller	08	PROGRAM	13
J. Precautions for remote controller	09	REPEAT	13
K. Application of remote controller	09	ROOT MENU/PBC	13
L. Description for pressing-keys of remote controller	10	DISPLAY	14
M. Basic operations	11	MUTE	14
Power ON/OFF	11	ZOOM	15
Disk loading	11	GOTO	15
Disk removing	11	AUDIO	15
USB and card reading	11	SUBTITLE	15
		TITLE MENU	15

Contents

VOLUME UP/DOWN	16	LANGUAGE SETUP	21
MENU SETUP	16	1.DISPLAY LANGUAGE	21
DIRECTION KEY	16	2.Audio/Subtitle/menu language	21
ANGLE	16	SPEAKEY SETUP	22
Number key and 10+ key . .	16	P.Description for playing of disks	23
USB/CARD	17	Playing Mp3 & JPEG disks . . .	24
TFT MENU	17	Disks available for this player	25
DVD/AV	17	MPEG4 decoding technology	25
TFT ON/OFF	17	Description for playing MP5 disks	25
Retutn	17	Q.Operation for game functions	26
A-B	17	R.Troubleshooting	27
O. Menu operation	18	S.Technical specifications	28
SYSTEM SETUP	18		
1. System	18		
2.AUTO Play	18		
3.Password	19		
4.Rating	20		
5.Default	20		

A. Precautions

Thank you to buy our product, please read the operation instruction carefully prior to operation so as to use the player correctly, and please keep it appropriately for future reference.

Warning

- For the sake of your safety, do not watch the video image or open the display in driving.
- Without the approval of authorized organization, any changing or rebuilding for the player shall cause troubles for user.

Caution

- The product has dangerous high voltage inside, non-professional personnel shall be not allowed to dismantle it and repair. If any trouble is found, please turn to the professional personnel or our authorized maintenance center.
- The player is equipped with TFT color LCD, it is frangible, to be careful in delivering and installing.
- Do not clean the device by corrosive chemical detergent, soft cloth is recommended.
- The operating voltage is DC 12V(+2V), the player shall be worked abnormally or be damaged if the voltage higher or lower than the allowed range.
- The player is equipped with radium emitting system, please read the instructions carefully for right operation and keep it well for future reference. If maintenance is needed, please contact the professionals, do remember to operate it according the correct operating procedure to avoid the harmful light beam, in order to prevent the direct radium light beam, do not open the enclosure without permission.

Special Tips

- In using, the LCD might has few bright spot on its screen, which is a very normal phenomenon in the active matrix display technology, and it doesn't mean the product has any fault or trouble.

B. Notice before operation

Safety

- Before operating the product, please check the voltage of your car and it should be consistent with the working voltage of the player.
- Do grasp the powerplug firmly in connecting or disconnecting to the power, do not pull the power line by force.
- The radium emitting light beam used by the product is harmful to eyes, do not dismantle the enclosure without permission and only the professional technicians are allowed to conduct the repair or maintenance.

Placement

- Please operate the product in proper temperature, the storage temperature should be -30°C to 75°C , and the working temperature should be -10°C to 55°C .
- To prevent dust falling on the laser head, it shall affect the playing effect, if the head is dusted, please use the laser head cleaning disk to clean. Refer to the instructions of purchased cleaning disk for detailed operation.
- It should be damp-proof, crash-proof and pressure-proof.

Dew

In the below conditions, moisture shall be formed on the lens (dew formation):

- Carry the player from the cold place to warm place;
- In the condition of big temperature difference such as at the moment of opening the heating device;
- If the dew is formed, it shall affect the normal work of the player, and please remove out the disk, lay the player on table for one hour under the condition of connecting to power so as to vapor the moisture.

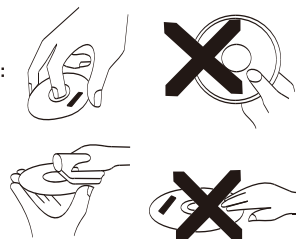

Precautions for disk

- In order to keep the disk clean, please take the edge of disk and do not touch its surface;
- Do not adhibit any paster or tape on the disk;
- Keep the disk away from direct sunshine or heat source;
- Please place the disk in the disk box after being used;
- Before playing the disk, if the disk is dirted, please clean it with soft cloth from the center to out;
- Do not use voatile oil and thinner to clean the disk.

C. Accessories

Please check the following accessories after opening the package.

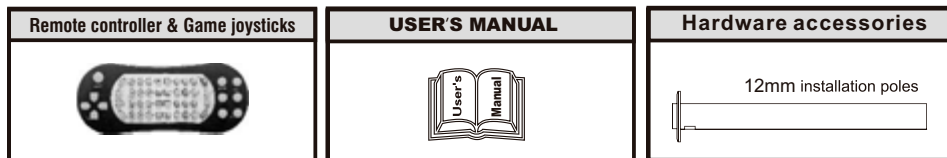

Note : the following three kinds of accessories (optional by customers):

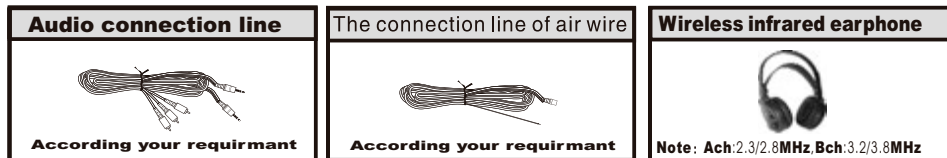

D. Feature

- Easy to install and it will not damage the car and the user might install it by himself;
- No additional player is needed for the integration of display and player;
- With built-in FM stereo emitting function, it could be connected by wirelessly with the original car FM radio part and enjoy the sound box effect through the loudspeaker of radio;
- The input ports of audio and video are provided for the connection with GPS navigation system;
- Audio and video output function and they are installed at the two side of car by pair to support the synchronous enjoyment of video image;
- With USB and cards reader functions, can use USB or SD/MS/MMC cards play MP3/WMA/MP4, also can download MP3/WMA/MP4 into USB or SD/MS/MMC through PC. Download the Native Games form this website : <http://www.native32.com>. Applying more kinds of games for you .

E. Video disk type

TYPE	RECORD FORMAT	HORIZONTAL DEFINITION	RECORD CONTENT	DISK SIZE
DVD	MPEG2	> 500 LINES	Audio+Video	12cm/8cm
VCD	MPEG1	> 240 LINES	Audio+Video	12cm/8cm
CD	Digital	—	Audio	12cm/8cm
Mp3	Digital	—	Audio	12cm/8cm
Mp4	MPEG4	>240 LINES	Audio+Video	12cm/8cm
WMA	Digital	—	Audio	12cm/8cm
JPEG	—	>500 LINES	Picture	12cm/8cm

F. System connection and installation

Check whether the shape and installation size is suitable, please select and employ suitable accessories and tool in disassembling and assembling.

The install method:

Takes down the original installation head rest, to select and match the steel pipe according to the original installation pole diameter for the head rest that having the DVD monitor, then the adjustment head rest steel pipe spacing, passed the power source and the audio frequency lines through the chair steel pipe, and connected on the power source, the sound and video frequency system with the vehicle. simultaneously the head rest will be fixed, and will freely to adjust the height, around size based on the front seat personnel request.

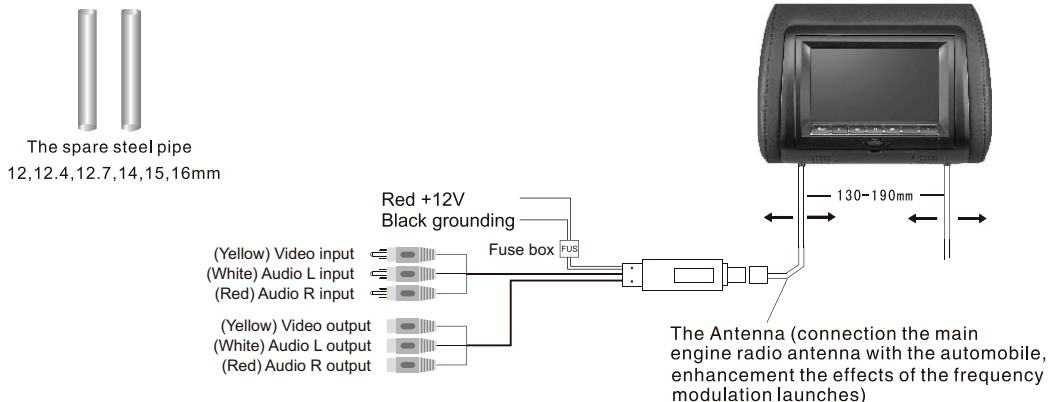

Note: the shape and installation size are not suitable for all cars, please select the suitable shape and installation size.

G. Key parts in front of the player

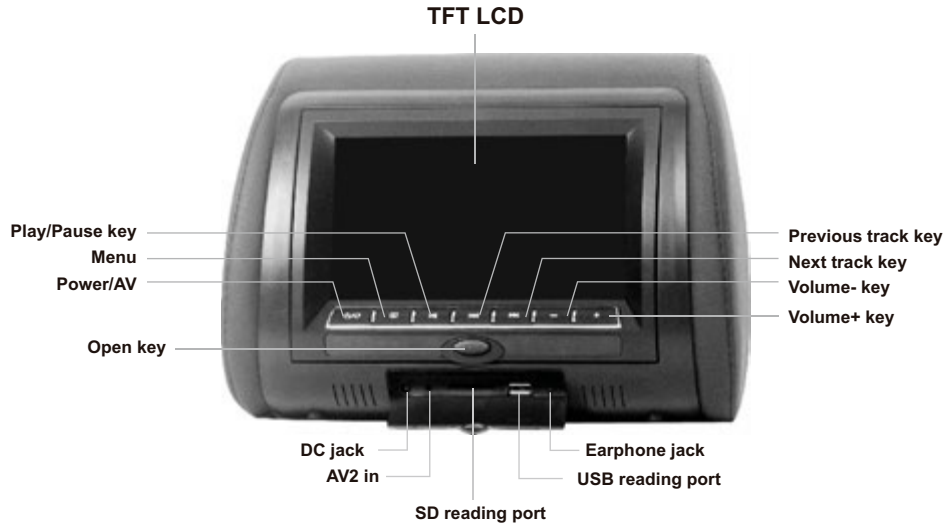

Note: At the Setup Menu ,press <<<< is up ,press >>>> is down , press < VOL- > is to left ,press < VOL+ > is to right,press <▶|> is enter.

H. Key parts at the player



Notice: Please carefully turns on the display monitor when vehicles start , please to close the display monitor after puts well the small dish as soon as possible, in order to avoid damages to the display monitor.

I. Battery installation of remote controller

1. please open the battery cover on the back of the remote control before using it.



3. we can begin to use remote controller after battery ready finish and close the battery cover.



2. please loading three NO.7 battery, please note have bellows side is negative.



Cautions:

In order to prevent the battery leakage, if the remote controller shall be not used for long time (longer than one month), please take out the battery, if there is liquid flowing out, wipe away carefully and then reload the new battery.

J. Precautions for remote controller

- For the first use, please first pull off the PVC sheet so as to electrify the remote controller;
- Take notice to protect the remote controller to avoid damaging;
- If there exists barrier between the player and the controller, the remote controller might be out of use;
- Do not place the remote controller under the strong light, or it might cause the unavailability of the device;
- Please operate the remote controller in the effective distance.

K. Application of remote controller

Application of remote controller:

- 1.Horizontal: $\pm 30^\circ$
- 2.vertical: $\pm 30^\circ$
- 3.Straight line: 3 meters

Caution:

The most functions could be operated by the remote controller and few functions only could be operated on the player.

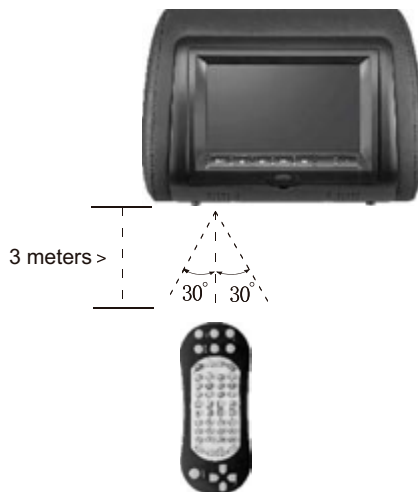

L. Description for the pressing-keys of remote controller

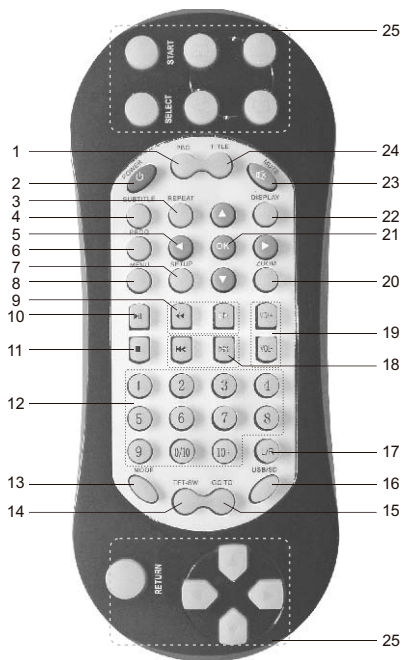

- | | |
|-----------------------------------|---|
| 1. PBC | Open/close the PBC menu in playing VCD2.0 and SVCD. |
| 2. POWER | Power on/off |
| 3. REPEAT | Multiple modes of repeat play shall be available. |
| 4. SUBTITLE | Subtitle switching, used for SVCD, DVD and MP4 disks with multiple subtitles only. |
| 5. Direction key | Direction selecting key. |
| 6. PROG | Track programming play. |
| 7. SETUP | Open/close DVD setup menu. |
| 8. MENU | Switching the menus of LCD brightness, contrast, definition, color and tint. |
| 9. Fast forward/
backward play | Fast forward or backward. |
| 10. Play/Pause | Play or pause |
| 11. Stop | Stop key |
| 12. Number key | Number selection |
| 13. MODE | DV/AV switching |
| 14. TFT-SW | TFT-LCD switch on/off |
| 15. GOTO | Select desired time to play |
| 16. USB/SD | Switching DVD/USB/SD CARD |
| 17. L/R | Language switching key, used for SVCD, DVD and MP4 disks with multiple languages only, channel switching key for VCD. |
| 18. Previous/Next | Select the previous or next track. |
| 19. VOL-/VOL+ | Adjust the volume. |
| 20. ZOOM | Zoom in/out, multiple modes. |
| 21. OK | Confirmation |
| 22. DISPLAY | Display the disk information and playing time. |
| 23. MUTE | Open/close the sound. |
| 24. TITLE | Press the key to return to the title menu in playing DVD disk. |
| 25. Wireless game control key | Wireless game control key area. |

M. Basic operations

The player may be used after being connected to the system.

1. Power ON/OFF

- (1) Press the Power key and the indicator shall be turned on ,after the screen appearance the player will begin read the disk ,if no disk inside ,the LCD will appear" No Disk".
- (2) In Power ON state, further press Power key to power off the player and the indicator shall be turned on.

2. Load disk

- (1) Press Eject key to open the disk door;
- (2) Load the disk (with the label side upwards).
- (3) Close the disk door.
- (4) The player shall play the disk automatically.



3. Remove disk

- (1) Press Stop key to stop playing;
- (2) Press Eject key to eject the door;
- (3) Take out the disk;
- (4) Put the disk back to the package bag or box for storage.

- Caution:**
- Be careful to take the disk, wrong operation shall damage the player;
 - Do not damage the disk, or the player shall be damaged;
 - Please keep the side with label upward if it's a single-side disk;
 - Be careful in playing two-side DVD disk for the two sides of the disk are available for playing;
 - Do not scratch the surface in taking the disk.

4. USB and card reading

- (1) The external USB memorizer (USB disk) might be connected by the attached USB connection line. In the state of Power OFF and no disk is loaded inside, connect the external memorizer to the corresponding USB port, and then press Power key to power on the player, the device shall detect the signal source automatically (including video, audio and image), and the player shall play automatically if the signal source format that complies with the player, is detected.
- (2) In the state of Power OFF and no disk is loaded inside, connect the external memorizing card (MS/SD/MMC card) to the corresponding port, and then press Power key to power on the player, the device shall detect the signal source automatically (including video, audio and image), and the player shall play in order automatically if the signal source format that complies with the player, is detected.
- (3) The contents of Mp3, WMA, Mp4 and JPEG formats could be downloaded from the internet through PC and be saved in the USB disk or external memorizing card to play.
- (4) Can download the Native Games form this website : <http://www.native32.com> into USB or use Memory Cards play the games on the Player directly.



- Caution:**
- Do not pull off the external memorizer when the player is connected with power, otherwise the external memorizer or the player shall be damaged;
 - Individual MP3 player couldn't play through USB device.

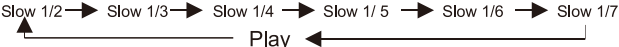

N. Functions of keys

KEY	Basic description
POWER	Power ON/OFF . Press the "Power" key of the panel to turn ON /OFF the player ,the power key at the top left angle of the remote controller just for the staying.
Open key	Open the disk door.
▶ Play/Pause	In normal playing state, press the key to pause to play image/sound. Further press the key to resume to play normally.
◀◀ Fast backward ▶▶ Fast forward	<p>Press Fast backward key, the image shall be played backward quickly, at the time, no sound shall be outputted, press the key successively, the player shall play the disk repeatedly as per the following method;</p> <p>Press Fast forward key, the image shall be played forward quickly, at the time, no sound shall be outputted,press the key successively, the player shall play the disk repeatedly as per the following method;</p> <p style="text-align: center;">Fast forward (backward) → X2 →X4 → X8→ X20 ▲————— Play —————▶</p>
◀◀ Previous ▶▶ Next	<p>Press the Previous key to select the previous track to play.</p> <p>Press the Next key to select the next track to play.</p>
■ Stop/ Return	<p>In playing VCD and CD disk, press" ■ " (Stop) key to display pre-stop state, at the time, press Play key to resume to play; further press Stop key to stop playing and return to the boot interface state.</p> <p>Return:In playing DVD or VCD2.0 disk,it plays the role of returning menu,and of stopping playing in playing menu.In playing game,press the key to return to the main menu of game.</p>

KEY	Basic description
SLOW	<p>Play by the lower speed, press the key successively to make the player play repeatedly, press " ⏸ " (Play/Pause) key to resume to play normally.</p> <p>In playing DVD disk:</p>  <pre> Slow 1/2 → Slow 1/3 → Slow 1/4 → Slow 1/5 → Slow 1/6 → Slow 1/7 ↑ ↓ └──────────────────────────────────┬──────────────────────────────────┘ Play </pre>
PROGRAM	<p>Setup of programming play: arrange the playing order of disk and then the player shall play the disks as per the arranged order.</p> <p>Note: the program key shall not be available unless PBC is closed, program is not allowed for MP3 disks; DVD disk should be programmed for its track time and VCD disks should be programmed for its track number. Finally, select Play key and the player shall play the disks automatically as per the arranged order, at the time, the number keys are not available, only the previous/next key could be used. If you want to cancel the programming function, press Program key to enter the menu interface and select Clear key and then press Enter key to confirm.</p>
REPEAT	<p>Repeat play</p> <p>Repeatedly play the selected title/chapter (DVD) or track/album (VCD/CD disk).</p> <p>In playing DVD disk, press the key successively to select the title or chapter of DVD to play. For other types of disks, press Repeat key successively to select one track or the album to play repeatedly.</p>
PBC/MENU	<p>In playing VCD2.0 or SVCD disk, the PBC menu function could be achieved by press PBC key, the disks could only be played in order if PBC is closed. In playing DVD disk, press the key to stop playing and return to the root menu of disk, press direction key or number key to select your desired contents and press Enter key to confirm, the player shall start to play as per the title or contents you setup.</p> <p>Note: PBC is not available in playing Mp3, CD or VCD 1.1 disks.</p>

KEY	Basic description
DISPLAY	<p>Press Display key for the first time, the LCD shall display: (DVD state)</p> <ol style="list-style-type: none"> 1) Disk format, current title number and total title number; 2) The Current chapter and total title number; 3) The playing of current title. <div style="text-align: center; background-color: #cccccc; padding: 5px; border: 1px solid black;"> DVD Title 1/1 Chapter 1/29 ⌚ 00 : 00 : 12 </div> <p>Further press the key to display: Display the current language and the language number supported, channel type, subtitle display language and angle type.</p> <div style="text-align: center; background-color: #cccccc; padding: 5px; border: 1px solid black;"> ○))) 2/3English 🎧 2CH 📺 OFF 🗣️ NO </div> <p>Press the key for the third time to display nothing. The display (OSD) in playing VCD disk is as follows:</p> <div style="text-align: center; background-color: #cccccc; padding: 5px; border: 1px solid black;"> VCD TRACK 2/15 🔊 PBC ↺ ⌚ 00 : 00 : 12 </div> <p>Display the disk format, current track and total track number, mute mode, PBC mode, and the track number of repeat mode, and the track playing time. The OSD of MP3 and CD disk is same with VCD except that VCD disk has PBC option.</p>
MUTE	<p>Firstly press the Mute key, the player shall play the image without sound output, further press the key to cancel the mute function and resume to play normally.</p>

KEY	Basic description
ZOOM	<p>Press Zoom key to zoom in the image. In playing, press Zoom key, the zoom mode shall be cycled as per the following order:</p> <p style="text-align: center;">ZOOM 2 → ZOOM 3 → ZOOM 4 → ZOOM 1/2 → ZOOM 1/3 → ZOOM 1/4 → ZOOM: OFF</p> <p style="text-align: center;">▲</p> <p>In Image Zoom state, press direction key"  " to move the image.</p>
GOTO	<p>GOTO: start to play from the selected time. Press GOTO key on the remote controller and a time selection dialog box shall be skipped out, move the cursor to the time number and input the time you want to select and then the player shall start to play from the selected time.</p> <p style="text-align: center;">DVD TITLE 1/1 CHAPTER 1/29  00:00:12</p> <p>Note: the setup of VCD disk is same with DVD disk, the input time couldn't exceed the longest time of the disk.</p>
AUDIO	<p>DVD disk supports eight languages at most, repeatedly press Language key to select the different language to play. If the disk hasn't the language menu, the user may also change the language by menu. In playing VCD or individual Mp4 disk, press audio key to channel mode. Note: Audio function is not available for MP3, CD, WMA, JPEG and individual MP4 disk.</p>
SUBTITLE	<p>Open/close the subtitle, select the subtitle on DVD disk and it's displayed on the TV screen, which is related to the format of disk. Subtitle is available only in the condition of the disk having subtitle function, the subtitle function is achieved by the Subtitle key on the remote controller, press the key successively to select different subtitles.</p>
TITLE	<p>Press Title key to stop playing and return to the title menu of disk, press direction key to select your desired title and press Enter key to confirm to enter the chapter menu.</p>

KEY	Basic description
Vol+ Vol-	Volume adjustment key Adjust the volume by the Vol+ and Vol- key on the remote controller
SETUP	Press the key to enter the setup menu to set up system, language, audio, video, loudspeaker and dolby digit, in setup menu, press the key to exit the menu interface.
 Direction key	Up/Down/Left/Right key Press the keys to select the disk content to be played and item to be set up as well as to select the image part to be zoomed.
ANGLE	Change the angle, DVD disk may record multiple scenes that are recorded from different angle, in playing, the user may select any one angle to watch. 1. Press Angle on remote controller to select angle 1 and the top right corner of the TV shall display:  2. Further press Angle on remote controller to select angle 2 and the top right corner of the TV shall display: 
1-0/10	Press any number key to select the track or chapter to be played and set up the playing time. The player features number key direct-selection function, press the your desired number to select. For example: select the 386 th track, first press number "3", and then press number "8", finally press number "6", the player shall play the 386 th track. Note: number key direct-selection function is available for Mp3, Mp4 and DVD disks only.
10+	For the track number bigger than 10, press the key first, the LCD will display 10+ and then press other number key to select, press the key in turn to achieve multiple modes

KEY	Basic description
USB/SD	Press this key enter the selecting menu of DISC/USB/CARD, use direction key and ENTER key select DISC、USB、CARD to play also can select in SETUP MENU.
TFT/MENU	The selecting key of TFT function can coordination with the direction key to adjust the brightness, contrast, color, definition, hue and other modes. After adjusting the parameters, press TFT MENU key to return and the set parameters shall be saved.
DVD/AV	Video/AV switching key. Press the key, the player shall switch DVD state into AV-IN state, the video signal inputted by the video terminal shall be displayed on the TV screen. If there is no signal inputted, it shall be blue screen. Further press DVD/AV key to switch AV-IN state into DVD state.

O. Menu operation

Press Setup key and the LCD will display the picture as figure 1, press [◀] and [▶] key to move the white bar to the designated position, press Enter to confirm to display its submenu, or press [▶] key to enter its submenu directly.

Note: no matter in which state, press "▲"/"▼"/"◀" and "▶" key to move the white bar and press Enter key to make it available, press [◀] key to exit the submenu at the right of LCD and at any time press Setup key to exit the Setup system.

Special Tips: for the company has many counterpart products, the figure is for reference only, all is subject the real product! The setup methods described in this instruction are for their common parts, other functions are recommended to use the default setup.

1. SYSTEM (see figure 2)

- (1) Press Setup key enter the setup system, select TV system and press Enter key to confirm, then the screen will display the picture as figure 2.
- (2) Enter the submenu, if you want to set the system to be PAL, select PAL and press Enter key to confirm, then press Setup key to exit the setup system.

Note: the video output system of TV set should be same with the video output system of DVD player.

Figure 1

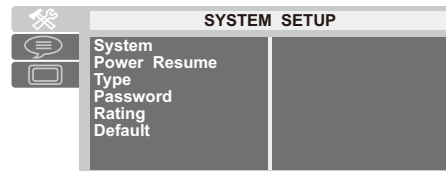
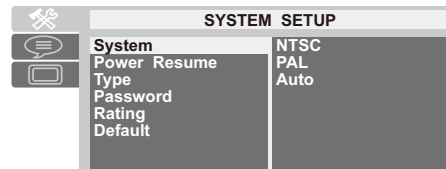

Figure 2



2. POWER RESUME (see figure 3)

- (1) Press Setup key enter setup system, select POWER RESUME then will display the figure 3.
- (2) Enter the submenu. If you want to open that function, select ON then press Enter key, then press Setup key to exit the setup system.

Figure 3

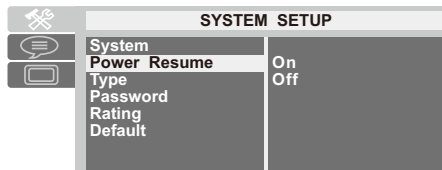

3. PASSWORD (see figure 4)

- (1) Press Setup key enter the setup system, select TV system and press Enter key to confirm, then the screen will display the picture as figure 4.

Figure 4

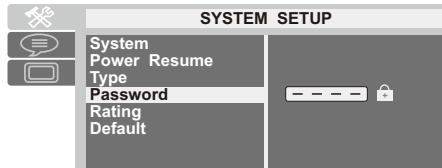

4. RATING (see figure 5)

Please check figure 5 for details, use directions buttons to choose what to setup.

Figure 5

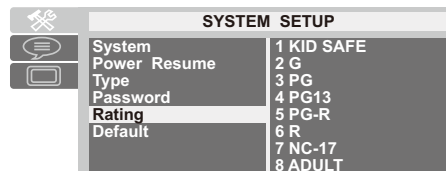

The screenshot shows the 'SYSTEM SETUP' menu with a list of options. The 'Rating' option is highlighted with a white background. To the left of the menu are three navigation icons: a wrench and screwdriver, a speech bubble, and a screen with arrows.

SYSTEM SETUP	
System	1 KID SAFE
Power Resume	2 G
Type	3 PG
Password	4 PG13
Rating	5 PG-R
Default	6 R
	7 NC-17
	8 ADULT

5. Default Value (see figure 6)

If you don't want to save the setup of the functions by yourself of the picture and voice of the player on the abnormal condition, please select Reset option and the DVD player will reset to the ex-factory parameters.

Figure 6

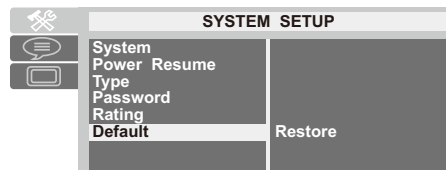

The screenshot shows the 'SYSTEM SETUP' menu with the 'Default' option highlighted. The 'Restore' option is visible in the right column. To the left of the menu are three navigation icons: a wrench and screwdriver, a speech bubble, and a screen with arrows.

SYSTEM SETUP	
System	
Power Resume	
Type	
Password	
Rating	
Default	Restore

Language Setup

1. Image Display Language (see figure 7)

- (1) Press Setup key and the TV screen will display the system setup picture, select Language Setup and then select Image Display Language option, press Enter key to confirm, the TV screen shall display the image as figure 9.
- (2) Select your desired language option, multiple languages are available for selection including: English, Chinese, German, Spanish, French and Portuguese. Select Enter key to confirm and then press Setup key to exit the menu setup.

Figure 7

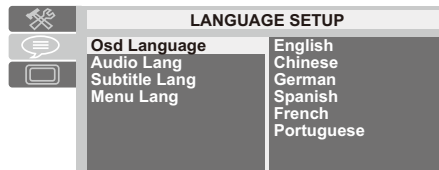

2. Audio language, subtitle language and menu language (see figure 8)

- (1) Press Setup key and the TV screen will display the system setup image, select Language Setup and then select your desired language option, press Enter key to confirm, the TV screen shall display the image as figure 8.
- (2) Select your desired audio, subtitle or menu language option, the available languages include English, Chinese, German, Spanish, French, Portuguese, Japanese and Latin. Press Enter key to confirm and then press Setup key to exit menu setup.

Figure 8



Video Setup



Speaker Setup

Press AUDIO key of remote control

Note:

LT/RT: if the disk has the PROLOGIC dolby stereo effect, the disk signal could present living cinema effect by decoded inside the player.

Stereo: for 5.1 channel output, the audio shall output two roads of signal (left channel and right channel); the common stereo signal shall be outputted.

Virtual surround: in playing 5.1 channel recorded disks, the main channel shall output the virtual surround effect.

Note: All setup option could exit the menu by pressing SETUP key. The system set up menu shall be a little different from the actual operation due to the software update; it shall be subject to the real product!

P. Description for playing MP5/MP4/MP3/WMA/JPEG disks

After loading the MP4/MP3/WMA/JPEG disks, the player shall search the directories automatically, after being searched, it will enter the directory of MP3 (for these disks of mix file placement), if it's the single file type of disk, it will enter the first directory and play the first track in this directory automatically (the cursor is stopped on the position of "01: ").

The screen will display as follows:

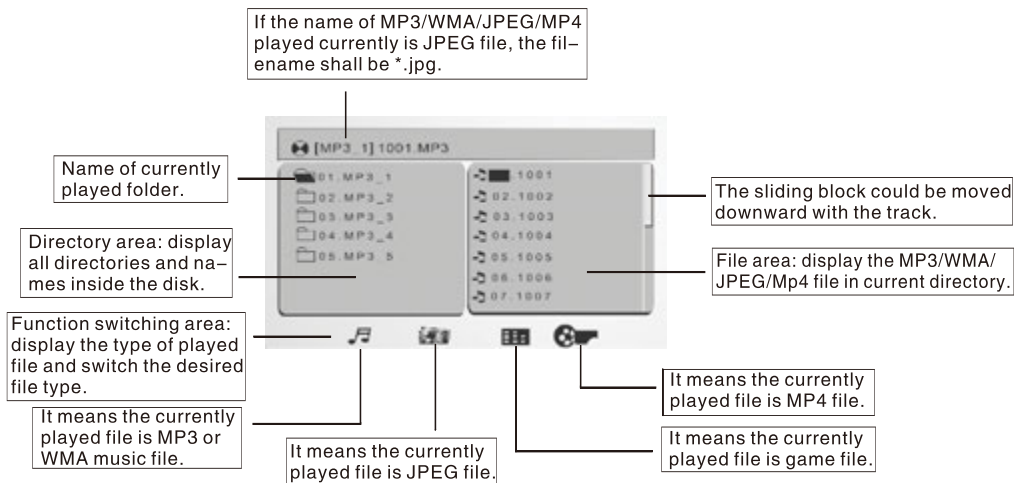

Electronic Album

The player features strong electronic album function, the user may record his/her photos in the video disk or external memorizer and browse the photos through the player, what's more, the user may zoom in or out the photo and turn it upward/downward/leftward/rightward, it's unnecessary to worry about the damage or loss of photos.

Playing JPEG Disks

1. Load JPEG disk, it shall stop on the first picture of the first directory after being searched;
2. Use the up/down key to select the picture file, press Play key or confirm to start to play from the selected file;
3. In playing pausing to play picture, you may press the direction key (up/down/left/right) to switch the display angle.

[▲] UP: turn the picture upward
[◀] LEFT: rotate 90 degree leftward

[▼] DOWN: turn the picture horizontally
[▶] RIGHT: rotate 90 degree rightward

Playing MP3 & JPEG Disks

1. In playing MP3 and JPEG mixing disk, if the user wants to browse the pictures in playing MP3, press direction key to move the cursor on the picture to be browsed, press Enter key to enter JPEG browse state.
2. Further press direction key to enter the picture play menu, after selecting one picture in the image directory menu, press Play key to play the pictures in order.
3. Press Left/Right key to switch the state between MP3 and image browse.

Caution:

- MP3 disk without image has audio signal output only;
- Some JPEG pictures couldn't be zoomed in for the inconsistent picture format.

MPEG4 Decoding Technology

MPEG4 is the widely-applied video image saving and transporting standard. The DVD is designed with MPEG4 file playing function skillfully, the user may not only enjoy the rich video/audio resource on the internet but also breach the limit of watching film on computer only. The user may use PC to download, record or transcribe and produce the MPEG4 disks, the better picture and sound quality could be achieved.

MPEG4 is the fourth version of audio/video standard by Moving Pictures Experts Group. MPEG1 is the video image compression standard of VCD; MPEG2 is the video image compression standard of DVD or super V; MPEG4 is one of the network video image compression standards, the video/audio file with MPEG4 technology features high compression rate and clear image. Generally, hundred or more OK songs or many films might be saved in one disk with better image quality than VCD or SVCD!

Note: in the current market, some disks marked with MPEG4 is Real Video actually or other formats (such as *.rm/ *.ra/ *.ram/ *.rmvb/ *.wmv/ *.ast), which couldn't be compatible with the international standard MPEG4, they could be played by special software only and couldn't be played by this player. Do identify it in buying disks.

Description for Playing MP4 Disks

The operation of MP3 disk is same with playing MP4 disk, MP4 disk has video image and auto play is the default setup for this player, press Stop/Return key to return to the menu to facilitate the user to select the menu.

Description for Playing MP5 Disks

1. MPEGLayer5 hereinafter referred to as a MP5, It is by our domestic manufacturers to R&D and promote to market.
2. MP5 player is adopted with the hard and soft multimedia processing technology to make products with high collaborative sex and expansibility, it is can via relatively low power consumption and technical difficulties save expenses, it is also the first to ARM11 platform to be used in hand-held multimedia terminal, the highest frequency up to 1 GHz, it is able to play more video formats, such as AVI, DAT, RM, RMVB etc, it is will give the consumer bring benefits and make industry bottleneck be solved.
3. About MP5, most of digital manufacturers can't given a specific definition, but we can simply understand that is MP4 with watch TV function, With the development of The Times, MP3, MP4 and other download audio-visual products already can't meet the needs of individualized and online consumption, MP5, its core function is the use of the ground and satellite digital TV channels let we can watch TV online or download digital video function include copy big memory DVD or all the photos built in to MP5 platform .

Q. Operation for Game Function

The player features superior intelligent game function, it will make you enjoy the wonderful game in spare time.

Operation for game function

1. Description for built-in game operation

On the no disk or stop playing status, press SETUP on the function controller or press SELECT on the game controller enter the menu, use direction key select EMBEDDED game or NATIVE game and press START on the game controller to enter the game.

2. Description for playing the game disk operation

(1) Load game disk (the disk for free), the game main menu shall be displayed in seconds.

(2) Press direction key of the function controller or game controller to select the games then press START on the game controller to enter the game.

3. Description for the wireless game controller

(1) Press SELECT to enter the menu of the built-in games.

(2) Press direction key to select the games you like, then press the START to enter the game.

(3) Enter the game, press the direction key to select upward/downward/leftward/rightward, A and B key to operate the functions.

(4) Press Return key on the function controller to exit the game.

If enter EMBEDDED game, press RETURN can return to the main menu, then use direction key select EXIT and press START on game controller to exit the game.

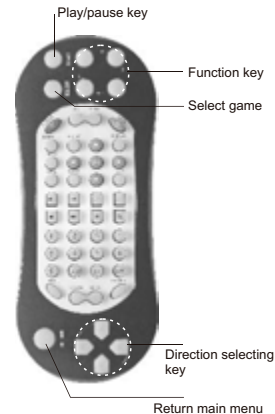

Caution:

1.Can not enter the built-in games when reading disk.

2.For different games,the function keys might be different,the user could get the know-how by trying several times

3.You can download games through PC from this website:<http://www.native32.com> into the USB or Memory Cards.

R. Troubleshooting

Troubles	Solutions
No response	<ol style="list-style-type: none">1. Check the power connection;2. Check the auto power is opened;3. Check the power is opened.
No sound	<ol style="list-style-type: none">1. Check whether the volume is on the Min. position or in Mute state;2. Whether at the status of FM transmitting or IR transmitting? Please select FM OFF and turn off IR Audio output function.3. No sound output in the following states: Pause/Fast Forward/Fast Backward/ Stop.4 Resume the default via setup system.
Image	<ol style="list-style-type: none">1. Check whether the player is in line input state, press DVD/AV to switch it to be DVD state;2. Check whether the brightness setup is appropriate.
The disk couldn't be read	<ol style="list-style-type: none">1. Check whether the disk has been loaded and the side with label is placed upward;2. The disk is damaged or dirtied, please load another disk or clean the disk;3. The region codes of disk and player are different;4. The disk format is wrong.
Improper image size	<ol style="list-style-type: none">1. Set up the TV system once again;2. Select the corresponding screen format from the setup menu.
The track couldn't be selected	<ol style="list-style-type: none">1. Some sections of some disks are not allowed to interrupt its set playing order.
The remote continueroller refuses to work	<ol style="list-style-type: none">1. Check whether there exists any barrier between the remote controller and player;2. The remote controller doesn't aim at the receiving head of player;3. Check whether the battery is installed correctly;4. Check whether the battery has enough electricity.

Do not dismantle the device to repair without permission!

S. Technical specifications and parameters

Product Name	AUTOMOBILE NEADREST DVD PLAYER
Disk type (signal source)	MP4/MP3/ DVD/SVCD/VCD/DVCD/CD/CDG/WMA/JPEG CD-R/CD-RW (these two types of disk should be played by the above coding formats)
Display	7-inch color LCD (16: 9)
Output Port	Audio: stereo Video: complex video signal output (AV) USB port (for spare) MS/MMC/SD CARD PORT (for spare)
Video System	PAL/NTSC/AUTO
Video Characteristics	Video Characteristics: 1.0Vp-p (75ohm)
Audio Characteristics	Frequency characteristics: 20-20KHZ (1dB) SNR: >90dB Total harmonic distortion: <0.01%
Power Voltage	DC: 12V/1.5A
Power Consumption	About: 12W
Working Temperature	-40°C ~ +60°C
Working Humidity	15~75% (No water drop is coagulated)
Net Weight	Approx. 1.7KG
Dimensions	(L)270mm x (W)160mm x (D)200mm

The logo for Pyle View is located in the upper left corner, featuring the word "PYLE" in a large, bold, sans-serif font with a registered trademark symbol, and "view" in a smaller, lowercase, sans-serif font below it. The text is white and set against a dark, stylized oval background. The rest of the image is a dark, high-contrast photograph of a car, likely a sports car, shown from a front-quarter perspective. The car's headlights and front grille are visible, though the overall image is very dark and moody.

PYLE
view

Visit us @ pyleaudio.com

IMPORTANT: Pack carefully in original package if possible. We are not responsible for damage incurred in returning items for repair. A letter stating your exact street address, daytime phone number, and the problem you are experiencing should be included. You must also enclose a copy of the original receipt a proof of date of purchase

Brooklyn, NY 11204

(718)535-1800

Monday Through Thursday, 9AM to 5PM

Friday 9AM to 1PM Eastern.