

IMPORTANT: PACK CAREFULLY IN ORIGINAL CARTON IF POSSIBLE. WE ARE NOT RESPONSIBLE FOR DAMAGE INCURRED IN RETURNING ITEMS FOR REPAIR. A LETTER STATING YOUR EXACT STREET ADDRESS, DAYTIME PHONE NUMBER, AND THE PROBLEM YOU ARE EXPERIENCING SHOULD BE INCLUDED. YOU MUST ALSO ENCLOSE A COPY OF THE ORIGINAL RECEIPT A SPROOF OF DATE OF PURCHASE

TECHNICAL SUPPORT HOTLINE

OUR TECHNICAL DEPARTMENT WILL GLADLY ANSWER ANY QUESTIONS YOU MAY HAVE ABOUT OUR PRODUCTS. THEY CANNOT, HOWEVER TELL YOU THE STATUS OF A REPAIR, OR HANDLE OTHER CUSTOMER SERVICE SITUATIONS



PYLE SERVICE CENTER
1600 63RD STREET
BROOKLYN, NY 11204
1-800-934-2277
WWW.PYLEAUDIO.COM

B00965

USER'S MANUAL

PLA2378
PLA2678
PLA2978
PLA4278
PLA4478
PLA1800
PLA3100D
PLA4600D



PYLE[®] POWER

HIGH SPEED CAR AMPLIFIER

WWW.PYLEAUDIO.COM

SPECIFICATION

	PLA2378	PLA2678	PLA2978	PLA4278	PLA4478	PLA1800	PLA3100D	PLA4600D
Channels	2	2	2	4	4	1	1	1
Output Power Rating @ 4 Ohms	2x1000W	2x2000W	2x2500W	4x500W	4x1000W	1x300W	1x900W	1x1200W
@ 2 Ohms	—	—	—	—	—	1x500W	1x1200W	1x1800W
@ 1, 3 Ohms	—	—	—	—	—	1x700W	1x1600W	1x2400W
Bridged @ 4 Ohms	1x2000W	1x4000W	1x5000W	2x1000W (2x500W+1x1000W)	2x2000W (2x1000W+1x2000W)	—	—	—
Maximum Power Output	2000W	4000W	5000W	2000W	4000W	2400W	3100W	4600W
Frequency Response	10Hz-50KHz	10Hz-50KHz	10Hz-50KHz	10Hz-50KHz	10Hz-50KHz	10Hz-300Hz	15Hz-150Hz	15Hz-150Hz
Input Sensitivity	0.2-5.0V	0.2-5.0V	0.2-5.0V	0.2-5.0V	0.2-6.0V	0.4-4.0V	0.2-6.0V	0.2-6.0V
Signal To Noise Ratio	>90dB	>90dB	>90dB	>90dB	>90dB	>95dB	>95dB	>95dB
THD&Noise	<0.05%	<0.05%	<0.05%	<0.05%	<0.05%	<0.01%	<0.01%	<0.01%
Low Pass Cross Frequency	40Hz-300Hz	40Hz-300Hz	40Hz-300Hz	60Hz-200Hz	60Hz-200Hz	40Hz-300Hz	40Hz-150Hz	40Hz-150Hz
High Pass Cross Frequency	40Hz-300Hz	40Hz-300Hz	40Hz-300Hz	15Hz-250Hz	15Hz-250Hz	—	—	—
Subsonic Filter	—	—	—	—	—	10Hz-40Hz	15Hz-55Hz	15Hz-55Hz
Bass EQ	0-12dB@45Hz	0-12dB@45Hz	0-12dB@45Hz	0-18dB@45Hz	0-18dB@45Hz	0-12dB@45Hz	0-12dB@45Hz	0-12dB@45Hz
Speaker Impedance	2-16 Ω	2-16 Ω	2-16 Ω	2-16 Ω	2-16 Ω	1-8 Ω	1-8 Ω	1-8 Ω
Fuse Size	2x15A	2x40A	4x30A	2x25A	2x40A	2x30A	4x25A	4x30A
Dimensions (LxHxW) mm	280x56x260	410x56x260	480x56x260	370x56x260	450x56x260	410x56x260	350x56x260	370x56x260

*All specifications subject to change without notice

Congratulations on purchasing the High Speed Power Amplifier. The amplifier has been designed using the latest electronic technology available, allowing you to produce high quality stereo reproduction in mobile applications. This system provides you with low harmonic distortion, a huge considerable amount of reserve voltage and high temperature stability.

Just enjoy the perfect sound this amplifier takes to you!

INSTALLATION

* Since the amplifier is sensitive to electrical and motor noise and interference from the amplifier may affect your radio reception, try to mount it at least 3 feet away from the receiver. Good locations include under a seat, in the trunk or hatch area.

* Please remember this is a high power unit which generates high electrical energy and heat. Therefore be sure to install the unit in a place with sufficient airflow, a minimum of dust and no moisture. Allow enough space around the cooling fins to permit reasonable airflow and cooling. It is important to ensure that the cooling fins of the heat sink are not against a panel or a surface preventing air circulation.

* Never mount the amplifier in a location that is subject to direct sunlight or exposed to moisture. Be sure to mount the amplifier to a strong, solid surface which will not give way under the stress of a sudden stop or accident.

* When mounting the amplifier on a side wall, try to position it so that the slots in the cooling fins are vertical. Amplifier should not be mounted on the bottom of a rear deck with the fins facing down because the heat will radiate back up into the amplifier. Leave yourself enough room on either side of the amplifier to make all the wire connections and adjust the controls. If you have a subwoofer box in your vehicle, you can mount the amplifier on the outside of the box.

Caution: If you are mounting the amplifier to the vehicle's floor, check beneath the car to be sure your screws won't puncture a brake or gas line.

WARNING!

Continuous exposure to sound pressure levels over 100dB may cause permanent hearing loss. High power autostereo system may produce sound pressure levels well over 130dB, use common sense and practice safe sound please!

POWER CONNECTION

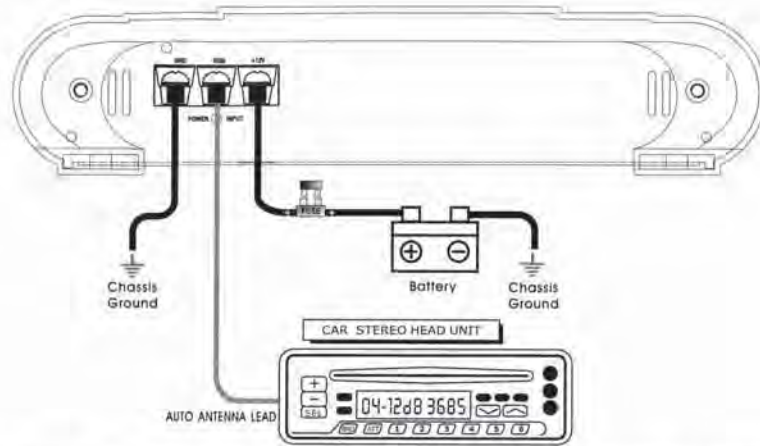

IMPORTANT! Before making any connections, disconnect the car's battery until the installation is completed to avoid possible damage to the electrical system

- * The +12V DC power cable should be heavy gauge stranded copper cable with heavy insulation, since it draws power directly from the positive battery terminal. Select the cable gauge at least 10mm². And the ground cable gauge should be the same as the +12V DC.
- * Connect the +12V Power terminal to the battery (+) position terminal. An in-line fuse must be installed in the +12V power cable near the battery less than 50mm. **Without one**, an accidental short circuit could pose a fire hazard and damage your amplifier. Connect the fuse holder to battery, however, do not install fuse at this time.
- * Connect the GROUND Power terminal directly to the battery (-) position terminal or the car chassis. Ensure that all paint or other insulation is removed from around the hole area, and using self tapping screw, securely affix the bare wire ends to the vehicle chassis. Use as short as possible.
- * Many radio's and other music sources have an output terminal for connection of the remote turn on of the power amplifier. CONNECT the output terminal to the amplifier REM control jack. If a radio doesn't have a remote turn on feature, you can connect the REM pole to external switch for positive +12V ON/OFF.
- * To help minimize interference, it is best to run the power cables along the opposite side from the audio cables.

Caution: The power cables must be connected tightly. A loose connection may cause malfunctions or interference noise or distortion.

MONO CHANNEL AMPLIFIER – APPLICATIONS

PLA3100D/PLA4600D

INTERCONNECTION EXAMPLE 1 Subwoofer with a Dual-Voicecoil

MASTER

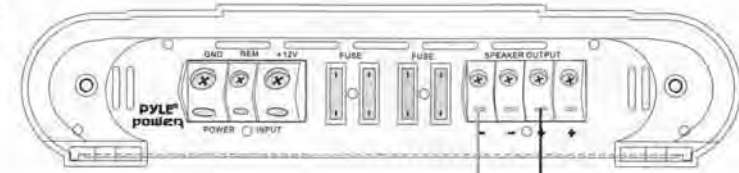

SLAVE

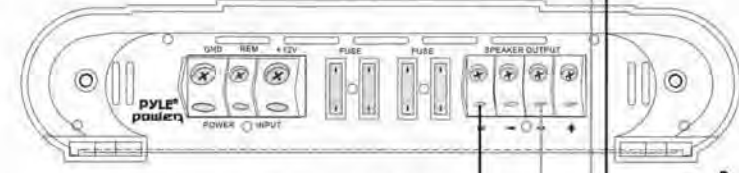

Subwoofer Voice Coil 2
1 – 8 Ohm

The subwoofer on the SLAVE amp needs to be connected with a converse polarity.



INTERCONNECTION EXAMPLE 2 Subwoofer with a Single-Voicecoil

MASTER

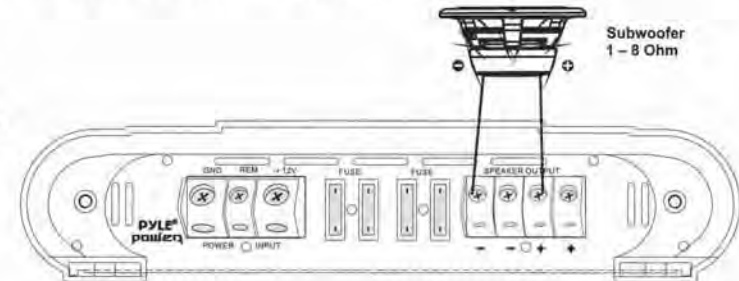

SLAVE

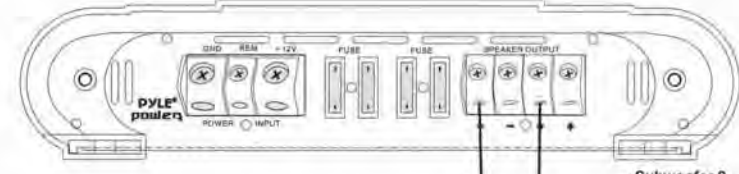

Subwoofer 2
1 – 8 Ohm

The subwoofer on the SLAVE amp needs to be connected with a converse polarity.



MONO CHANNEL AMPLIFIER – APPLICATIONS

PLA3100D/PLA4600D

INTERCONNECTION EXAMPLE 1 Subwoofer with a Single-Voicecoil
MASTER/SLAVE Link like described on page 17.

MASTER

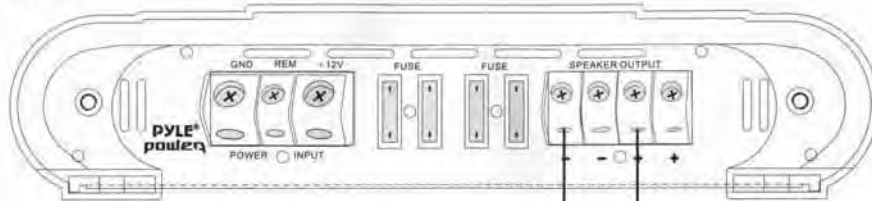

SLAVE

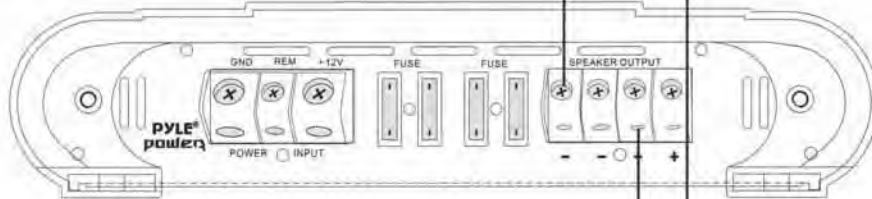

Subwoofer
2-8 ohm

2 CHANNEL AMPLIFIER – FEATURES

PLA2378

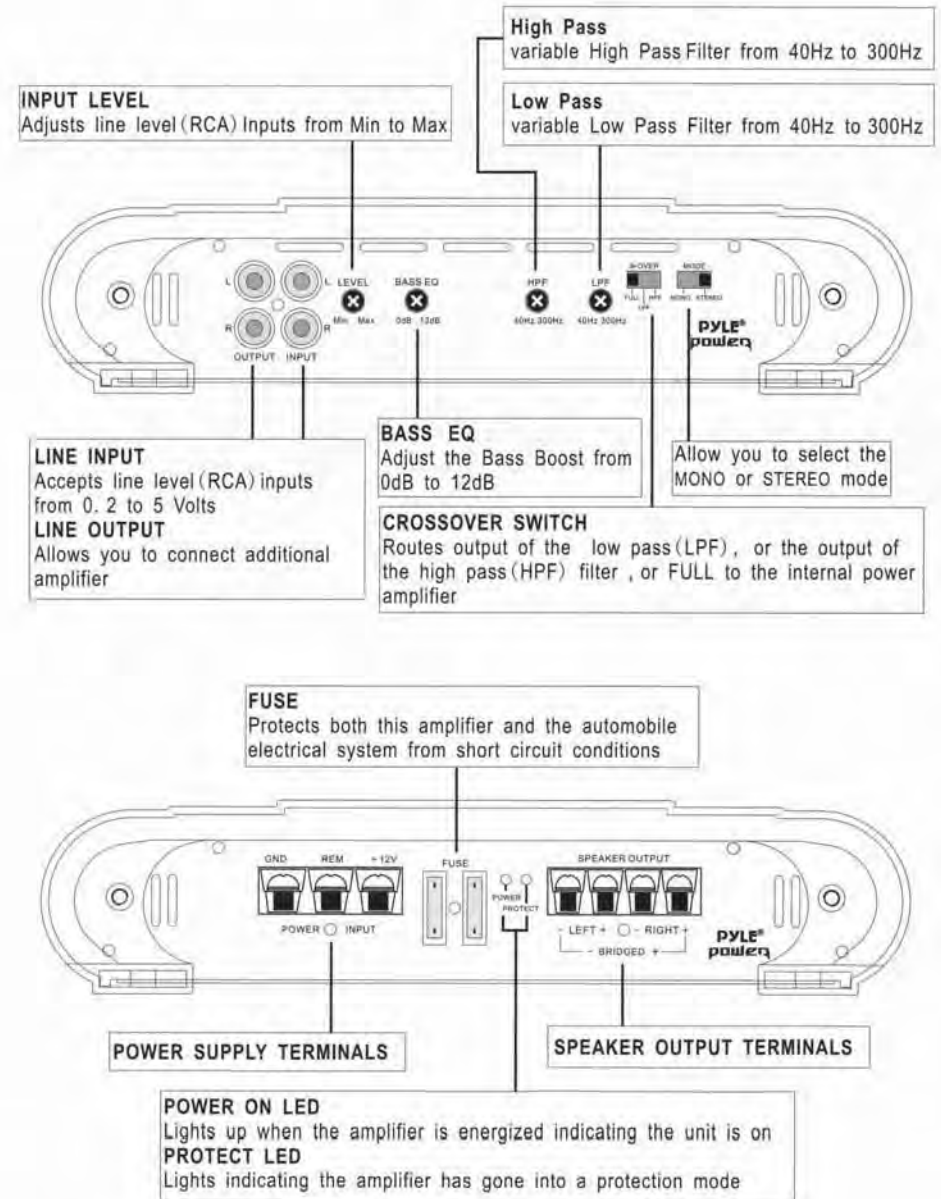

4 CHANNEL AMPLIFIER – FEATURES

PLA4278/PLA4478

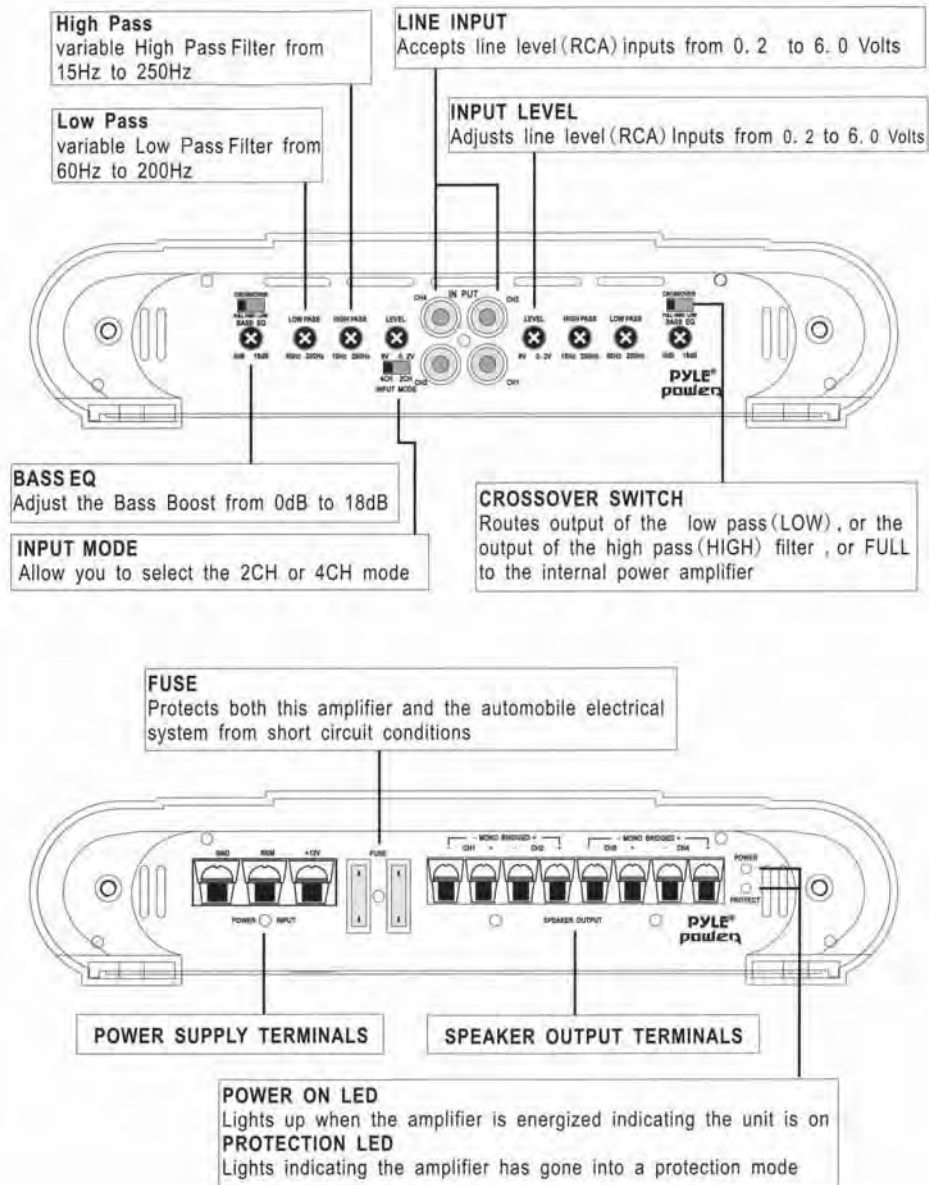

MONO CHANNEL AMPLIFIER – APPLICATIONS

PLA1800

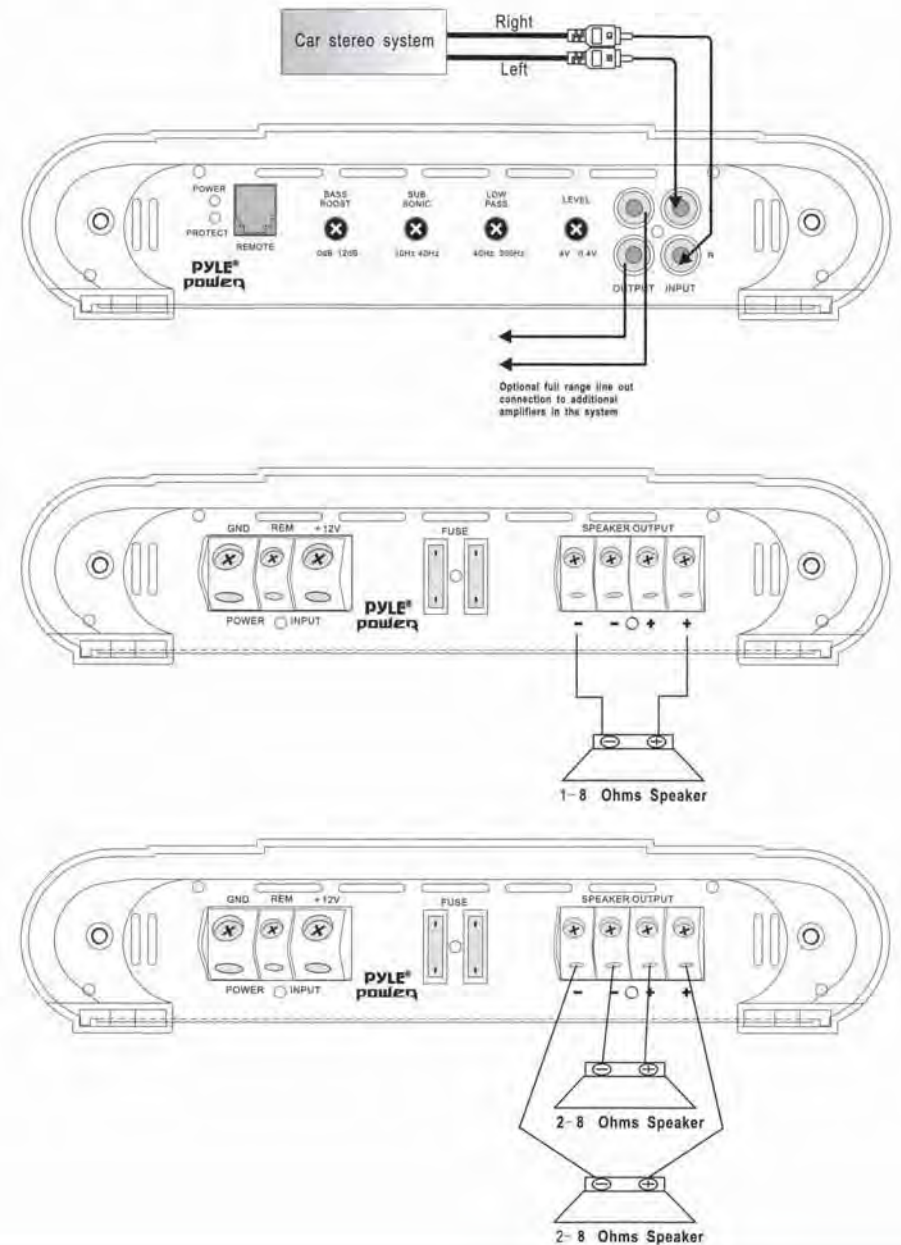

MONO AMPLIFIER – APPLICATIONS

INPUT CONNECTIONS

* This amplifier has RCA connections for low level inputs. Low level signal is carried through RCA cables. It is preferred to use low level inputs to the amplifier if the head unit is equipped with the low level outputs.

SPEAKER OUTPUT CONNECTIONS

You do not need to make any adjustment for the input connection of amplifier before you connect the speaker output.

* Connect subwoofer wire to corresponding speaker output terminals of the amplifier.

* Be sure to have the positive wire from the speaker to the positive speaker terminal of the amplifier and the negative wire from the speaker must connect with the speaker terminal of the amplifier. Reversing any of these connections will result in the speaker cones moving out of phase which causes bass cancellation.

LEVEL CONTROLS

Turn the VOLUME control on the amplifier to Min initially. Once the initial power sequence has been performed, set the CD/RADIO volume control to roughly 80% of full. Insert a CD or tune to a radio station and slowly turn up the amplifier VOLUME control until you hear some distortion, and then back it off for clean sound.

MONO CHANNEL AMPLIFIER – FEATURES

PLA1800

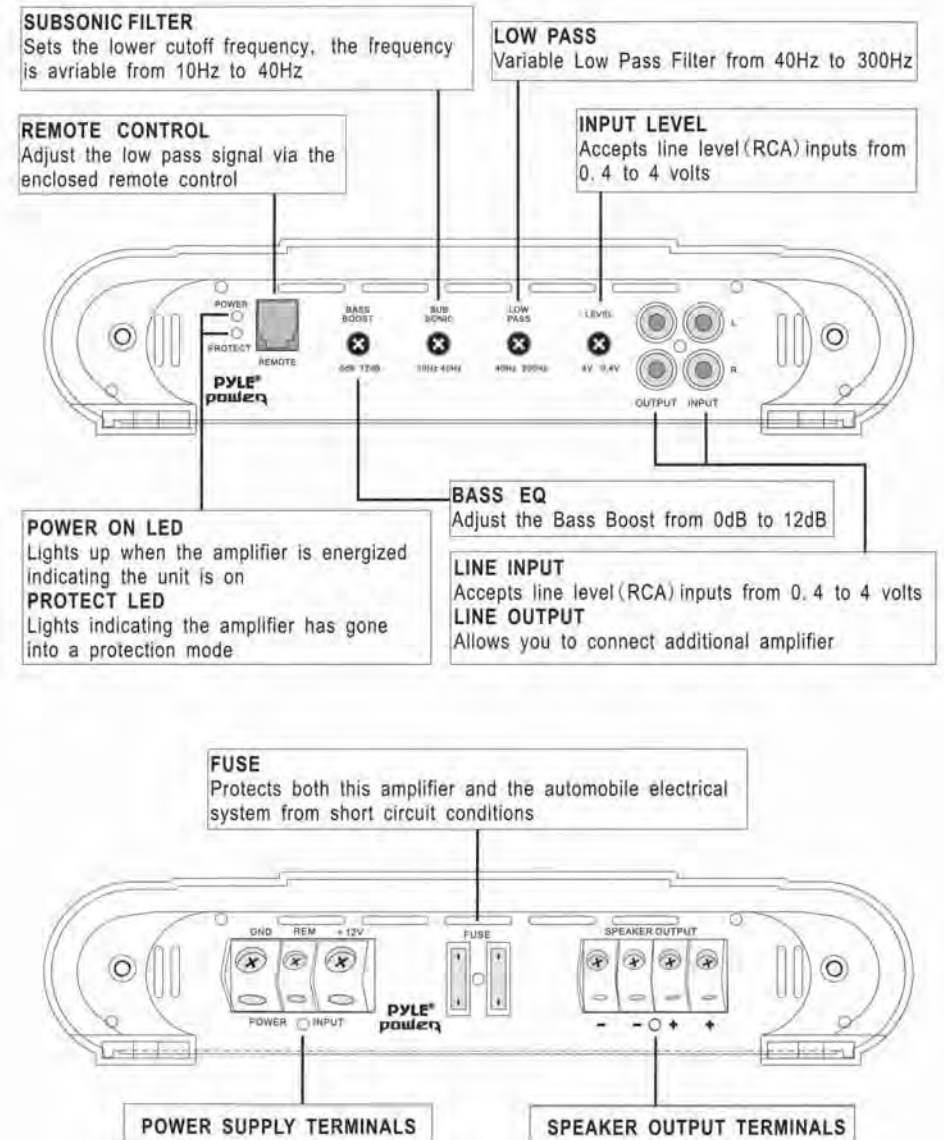

MONO CHANNEL AMPLIFIER – FEATURES

PLA3100D/PLA4600D

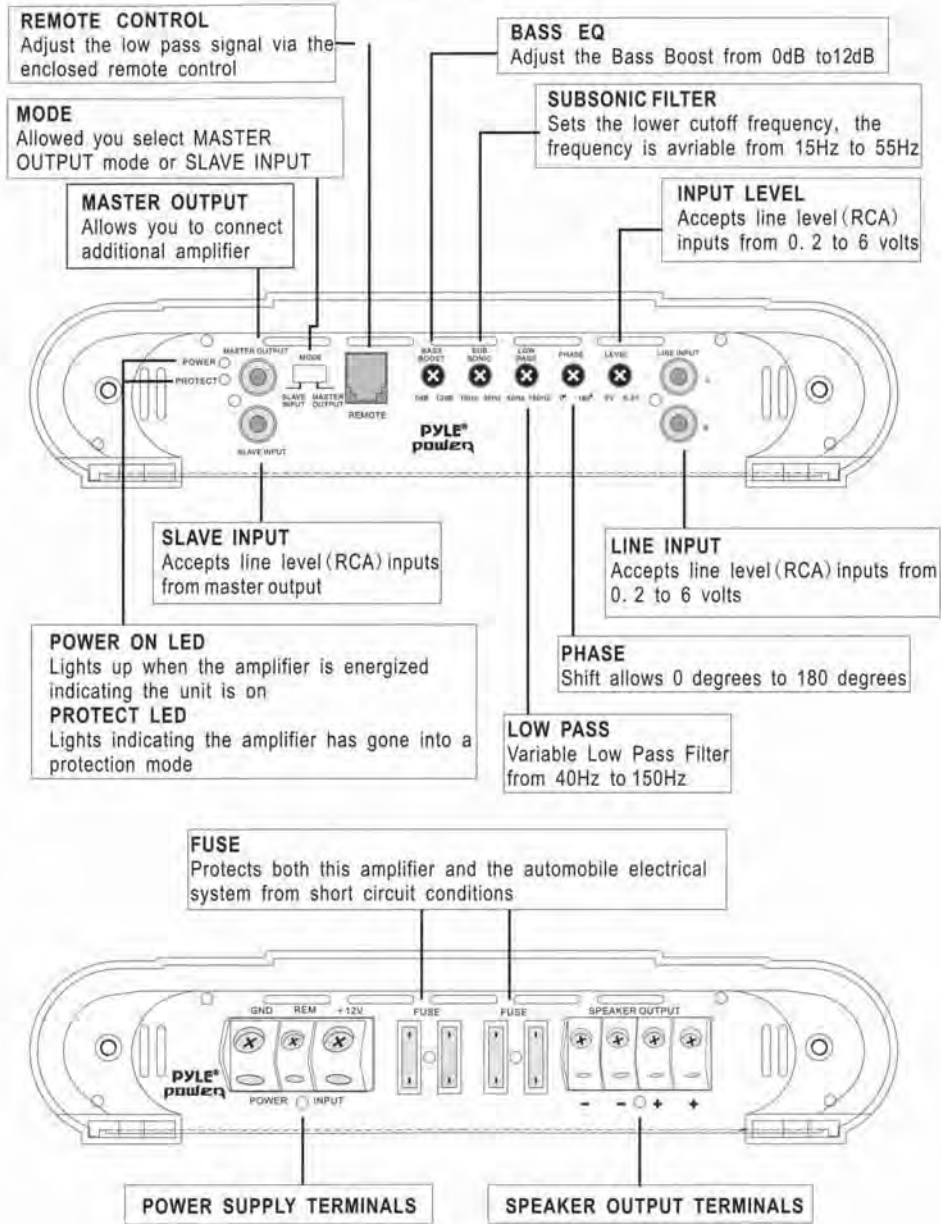

4 CHANNEL AMPLIFIER – APPLICATIONS

PLA4278/PLA4478

3-CHANNEL MODE

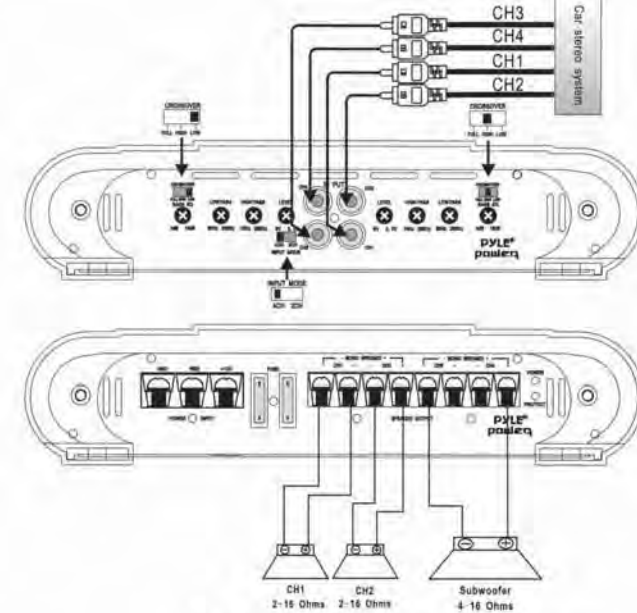

2-CHANNEL MODE

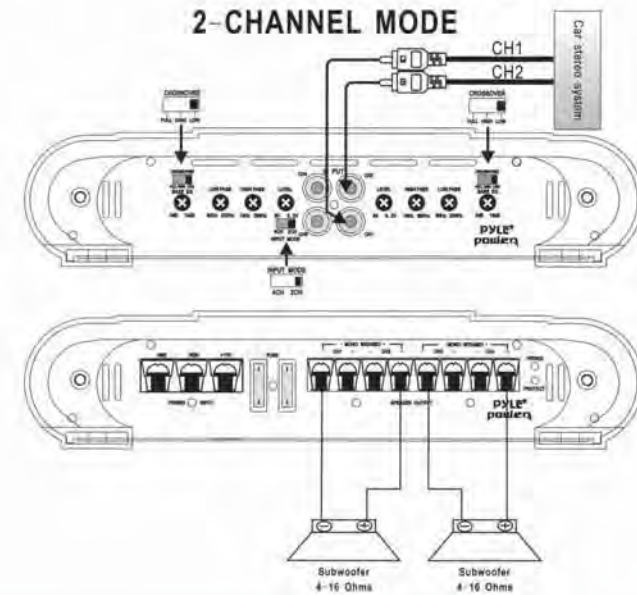

4 CHANNEL AMPLIFIER APPLICATIONS

PLA4278/PLA4478

4-CHANNEL MODE

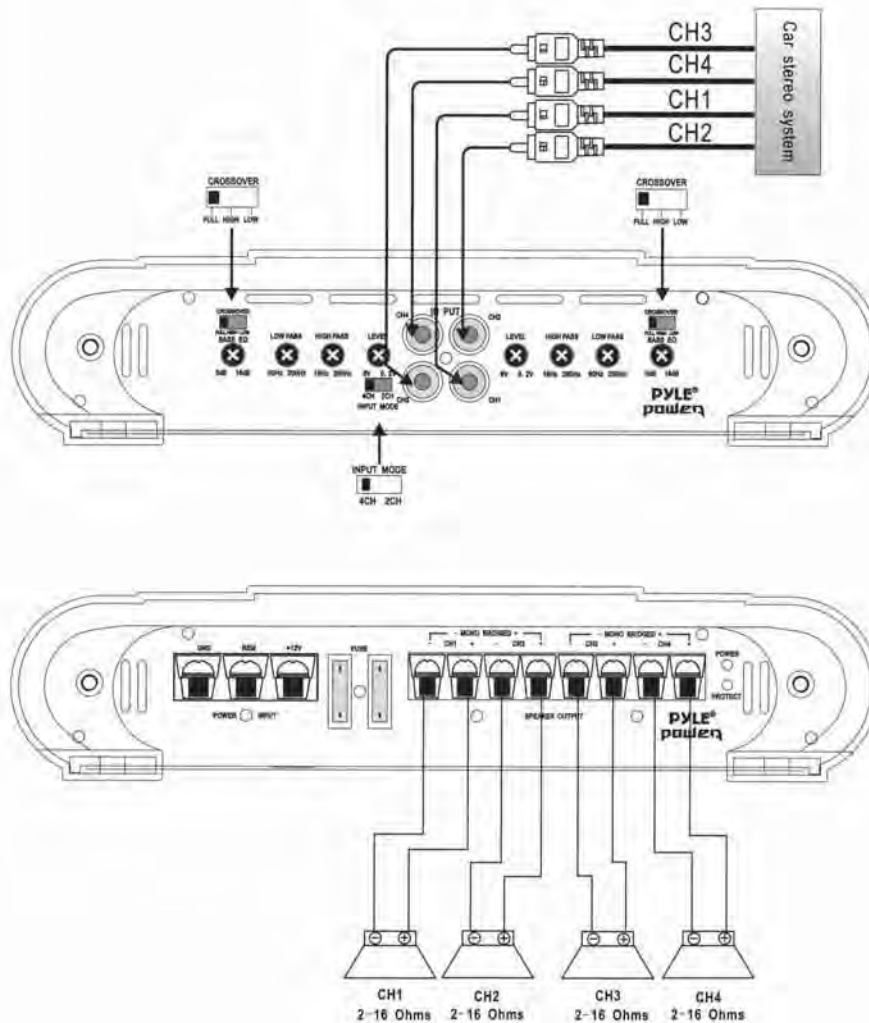

2 CHANNEL AMPLIFIER – APPLICATIONS

INPUT CONNECTIONS

* This amplifier has RCA connections for low level inputs. Low level signal is carried through RCA cables. It is preferred to use low level inputs to the amplifier if the head unit is equipped with the low level outputs.

* This amplifier has high input connection. High level input is used from radios that do not have line-level outputs.

* **Be sure not to use both low and high level inputs simultaneously!**

SPEAKER OUTPUT CONNECTIONS

You do not need to make any adjustment for the input connection of amplifier before you connect the speaker output.

* Connect right and left speaker wire to corresponding speaker output terminals of the amplifier.

* Be sure to have the positive wire from the speaker to the positive speaker terminal of the amplifier and the negative wire from the speaker must connect with the speaker terminal of the amplifier. Reversing any of these connections will result in the speaker cones moving out of phase which causes bass cancellation.

LEVEL CONTROLS

Turn the VOLUME control on the amplifier to Min initially. Once the initial power sequence has been performed, set the CD/RADIO volume control to roughly 80% of full. Insert a CD or tune to a radio station and slowly turn up the amplifier VOLUME control until you hear some distortion, and then back it off for clean sound.

2 CHANNEL AMPLIFIER – APPLICATIONS

PLA2378/PLA2678/PLA2978

STEREO MODE

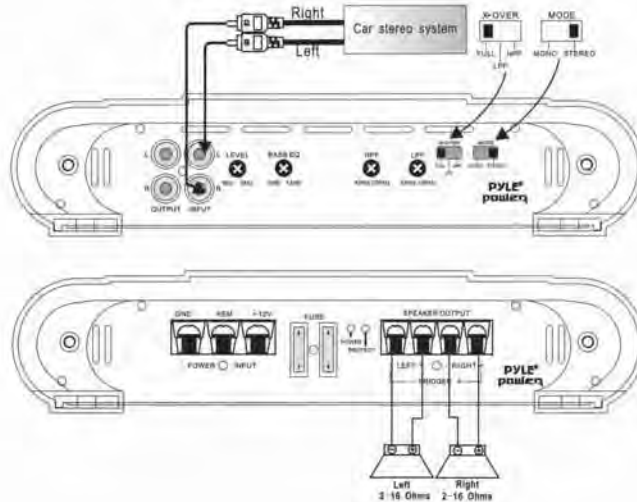

MONO MODE

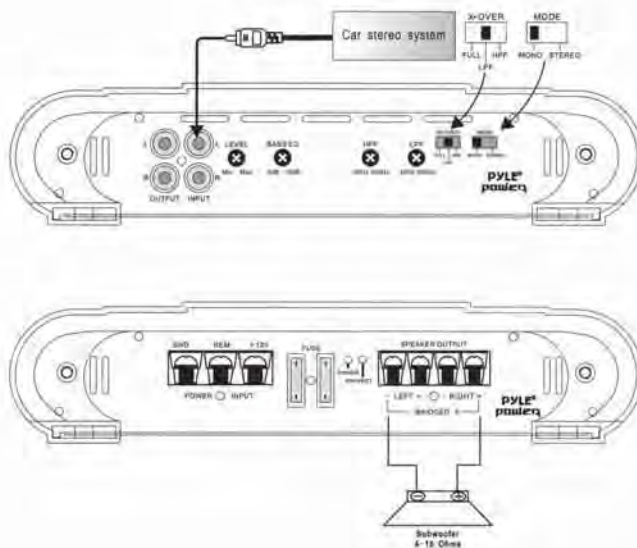

4 CHANNEL AMPLIFIER – APPLICATIONS

INPUT CONNECTIONS

* This amplifier has RCA connections for low level inputs. Low level signal is carried through RCA cables. It is preferred to use low level inputs to the amplifier if the head unit is equipped with the low level outputs.

SPEAKER OUTPUT CONNECTIONS

You do not need to make any adjustment for the input connection of amplifier before you connect the speaker output.

* Connect right and left speaker wire to corresponding speaker output terminals of the amplifier.

* Be sure to have the positive wire from the speaker to the positive speaker terminal of the amplifier and the negative wire from the speaker must connect with the speaker terminal of the amplifier. Reversing any of these connections will result in the speaker cones moving out of phase which causes bass cancellation.

LEVEL CONTROLS

Turn the VOLUME control on the amplifier to Min initially. Once the initial power sequence has been performed, set the CD/RADIO volume control to roughly 80% of full. Insert a CD or tune to a radio station and slowly turn up the amplifier VOLUME control until you hear some distortion, and then back it off for clean sound.