



**Model:**

# **PLDNB78i**

7" Touchscreen Double DIN  
Stereo Receiver Headunit



## Thank you for choosing Pyle Audio!

To enjoy of the unit's features, along with proper and safe operation, please be sure to read through this manual before use. It is especially important to thoroughly understand and follow all system warnings and precautions. Keep the manual in a safe location for future reference when necessary. Contact your dealer or the nearest authorized repair center for any service, repair or technical support assistance.

<b>Contents</b>	
Precautions	2
Double DIN Installation Guide	3
Installing Steering Wheel Control	3
Remote Control	4
Front Panel and Buttons	5
Turning Power On	5
Graphics User Interface	6
Settings	7
Set Time	7
Sound	7
Aux	7
Calendar	7
Calculator	8
EQ	8
Games	8
Radio	9
SD	9
USB	10
Video	10
Wallpaper	10
Wheel	10
Trouble Shooting	10
Wiring	12
DVD Playback	14
Bluetooth	15

*Note:* Pyle Audio is constantly aiming to improve the customer experience and your receiver's features and specifications are continually changing for the better, with improvements to the user interface experience, software updates, bug fixes, etc. System descriptions and features reflected as herein stated by this user manual serves to express the Pyle Audio Headunit Receiver features at the current production period. We reserve the right to change terms and conditions of system specifications, features and descriptions at any time, as we continue to improve and provide our customers with upgrades in safety, performance and system operation in general. For questions, comments and concerns, visit [PyleAudio.com](http://PyleAudio.com) for more information.

visit [www.PyleAudio.com](http://www.PyleAudio.com) for the latest products & up-to-date model specific information

## Compatibility

This unit is a standard "Double Din" sized radio. Check to see that your vehicle accepts a double din sized radio. This unit conforms to the standard size and dimensions of a double din radio. Your vehicle may require a vehicle specific or 3<sup>rd</sup> party double din installation kit.

## Precautions & Warnings

Please take a moment to read through this information booklet and heed all precautions to ensure a positive user experience.

For your safety, you must not operate the head unit's controls while driving. Make sure you have the volume set to a level where external sounds are still audible.

Do not watch the monitor, or attempt to operate any of the multimedia features while driving. If the parking brake is not engaged video playback will be disabled for your safety.

### *Cleaning*

Clean the LCD with a slightly damp cloth. Keep the screen clean and free of any debris.

Do not use solvents such as alcohol, benzene, thinner, commercially available cleaners or antistatic spray. When wiping the screen be sure not to scratch the surface.

### *Temperature*

In cold weather, check for condensation on the disc. If found, wipe the moisture from the disc and do not operate your player for an hour until condensation disappears from the unit's optical reader.

### System Handling

Screen may not be clear if the temperature of the vehicle is too cold or too hot. The picture will return as the car's temperature returns to normal. Never touch the screen, or operate the touch screen, with anything besides your finger(s). When the display is subject to direct sunlight and glare, the unit may become hot resulting in possible damage to the LCD display. Avoid exposing the display to excessive sunlight as much as possible.

### *Note:*

Driving on rough terrain may cause the disc to skip during playback.

In the event of a malfunction, never open the unit's casing or lubricate any parts. Contact Sound Around USA for repair information. If liquid or any other foreign substances enter the unit, turn the power off immediately and consult your dealer or the nearest authorized repair center. If you notice smoke, irregular noises or smells coming from the unit, power off immediately and consult your dealer or the nearest authorized repair center. Do not attempt to disassemble or modify the unit as there are sensitive and high voltage electronic components which can cause damage to the unit, or to one's self, if handled improperly. Be sure to consult your dealer or the nearest authorized repair center for any technical assistance.

This equipment has been tested and found to comply with the limits of a Class B digital device, pursuant to Part 15 of the FCC rules and regulations. These limits are designed to provide reasonable protection against any harmful interference in a residential installation. This equipment generates, uses, and can radiate radio frequency energy. If not installed and used in accordance with the instructions, the unit may cause harmful interference to radio communications. If the unit is found to cause harmful interference the user is encouraged to consult an experienced radio technician.

## System Installation:

*Before starting:* To prevent short circuits, be sure to disconnect the battery terminal before starting.

## Installation Guide - Double Din Fitting:

*Caution:*

- 1) This screen opens up. Install the unit within 30 degrees of the horizontal plane. Check that the screen has enough room to fully open. Restricting screen movement will cause damage to the mechanism.
- 2) Consult your vehicle dealership before making any modifications to your car's body (ex. Drilling holes)
- 3) Use included screws in installation. Improper hardware may result in damage.

Do not install unit in any area where:

- It may obstruct the steering wheel and gearshift lever operations
- It may obstruct the operation of safety devices such as air bags
- It may obstruct visibility

### Installation kits:

This unit conforms to the standard size and dimensions of a double din radio.

Your vehicle may require a vehicle specific or 3<sup>rd</sup> party double din installation kit.

Consult your dealer or the nearest authorized repair center for any technical assistance.

*\*Mounting Sleeve Bracket not included*

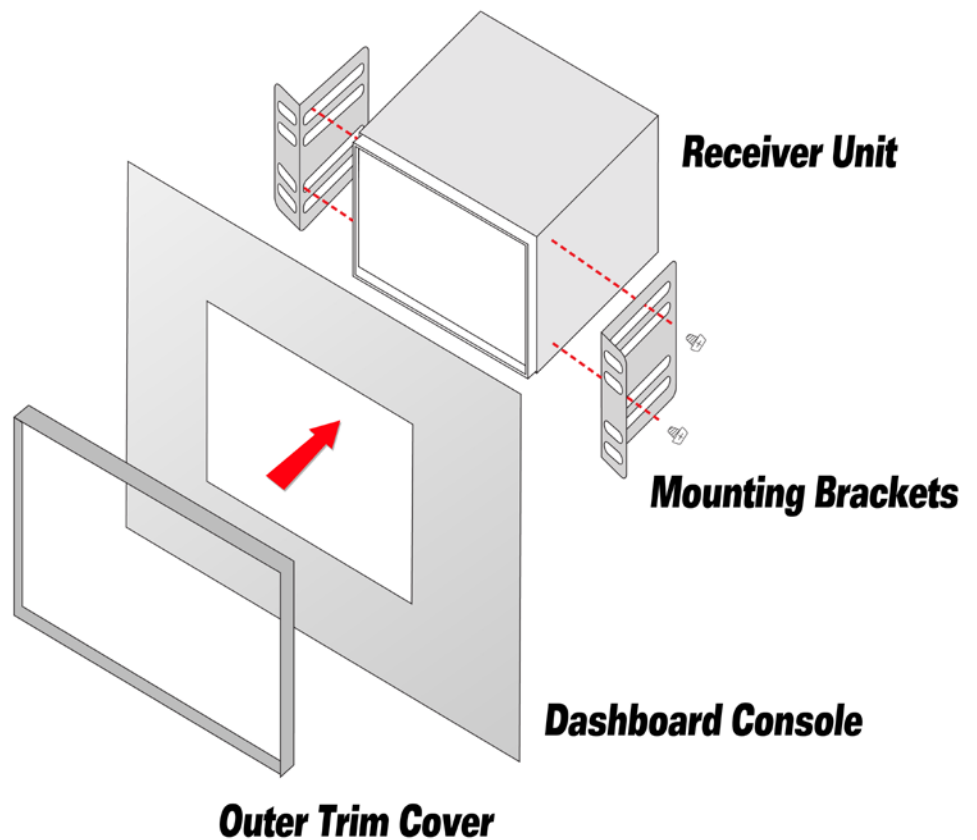

\*Ensure that the opening or closing of the in-dash unit, when mounted, so as it will not interfere with any of your vehicle's interior panels, consoles, gear shifts, etc. Ensure not to use elongated screws when installing / securing your unit to the in-dash console to avoid damage.

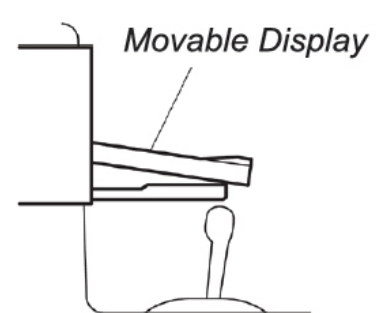
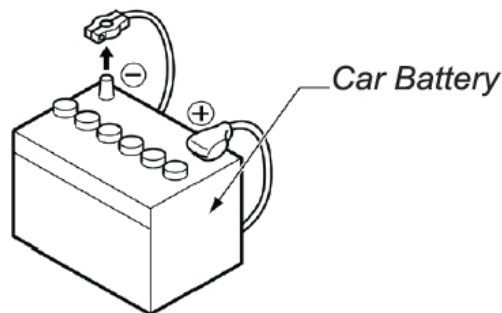

## Installing Steering Wheel Control

Note on compatibility: This unit is a dual wire code learning Steering wheel interface, adaptable to any vehicle with existing steering wheel controls. This unit has the ability to wire directly to your vehicle's steering wheel column and does not, but may, require a 3<sup>rd</sup> party steering wheel control interface. Pyle Audio Technical support can assist you in interfacing into vehicles with existing steering wheel controls. For additional help, contact Pyle Technical Support and be sure to supply Year Make Model and options of vehicle so that proper instructions can be supplied.

Key 1 and Key 2 wires are used for setting up steering wheel controls. The location of the attachment wires in the steering wheel column varies between different vehicle makes and models.

## Remote Control

Factory batteries are sometimes depleted from extended storage time. Replace the batteries if the unit does not respond to the remote. Also note that Pyle Receiver Remotes are universal and used between multiple radio models, which may or may not, have some buttons / functions that do not work or provide other functionality with your receiver headunit. If some functions respond your remote is not defective. Contact parts at [www.PyleAudio.com](http://www.PyleAudio.com). Goto "contact us" - "parts" if you believe your remote is defective.

## Button Layout



	Power ON/OFF		Select (CD/DVD)
	Opens the Motorized Unit / Ejects CD		AMS - Automatic Search (Radio Stations)
	Input Source Selection / AUX-in		Left (...to Navigate Selections)
	Home Screen / Menu interface		Enter / Confirm (...to Navigate Selections)
	Downward / Motorized Screen Tilt Adjustment		Right (...to Navigate Selections)
	Next / Hold for Fast Forward (CD/DVD)		End Call / Hang Up (...in Bluetooth Interface)
	Upward / Motorized Screen Tilt Adjustment		Down (...to Navigate Selections)
	Main Menu (CD/DVD)		Call / Dial Number (...in Bluetooth Interface)
	Volume -		File Information (CD/DVD - if compatible)
	Play / Pause		Playlist Key List (CD/DVD - if compatible)
	Volume +		Options / Settings
	Mute		CD/DVD Menu Control
	Stop (CD/DVD) / Switches AM/FM		Repeat Modes (CD/DVD - Media Playback)
	Previous / Hold for Rewind (CD/DVD)		Left / Right / Stereo Audio Selection
	Up (...to Navigate Selections)		CD/DVD Angle Adjustment (if compatible)



## Front Panel and Buttons



### Button & Feature Layout

<b>Mic</b>	Microphone port
<b>Power/Mute</b>	Hold to power up / shut down unit. Short press while unit is on to mute the volume output
<b>Home</b>	Switch between apps/radio interface, Press while in GPS interface to return to radio apps
<b>Navi</b>	Press to load GPS software from SD map card
<b>VOL-</b>	Volume down
<b>VOL+</b>	Volume up
<b>^</b>	Position screen tilt upward
<b>▼/Eject</b>	Position screen tilt upward Hold to open screen and eject disk.
<b>RES</b>	Use a pin to insert into reset port to trigger unit reset. (Hold for 20 secs. to reset)
<b>USB</b>	Mini USB port type B
<b>IR</b>	IR remote receiver port

(Motorized screen slides open to reveal additional features )

\*CD/ DVD Slot

\*SD Memory Slot

\*GPS Card Slot (USE FOR GPS PROGRAM SOFTWARE ONLY)

### Turning Power On

- 1) Turn on the engine key to the “ACC” or “ON” position
- 2) Press and hold the power button for 3 seconds  
-When the engine key is turned to the off position the unit is turned off

*Status Bar (Along top of radio screen and app screen)*

- 1) Home Icon – Switch between “app screen” and “radio interface”
- 2) Moon and star Icon – Turn off display (Awaken by tapping screen)
- 3) Time display
- 4) Current volume setting
- 5) Media status icons (Illuminate to show media is available)

Visit [www.PyleAudio.com](http://www.PyleAudio.com) for additional and detailed model-specific information.

## App Screen - Interface Layout

A flashing app in this screen indicates that it is a currently selected source.

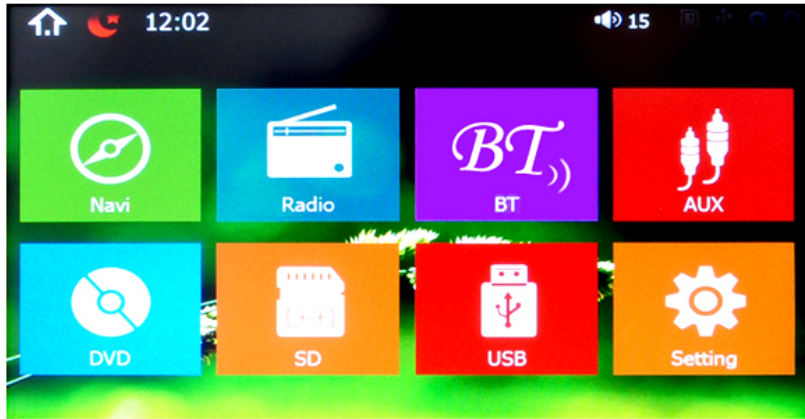

<b>Navi</b>	Loads Navigation software
<b>Radio</b>	AM/FM Tuner
<b>BT</b>	Bluetooth
<b>AUX</b>	Auxiliary Audio Video Input
<b>DVD</b>	DVD / Multi-media Disc Player
<b>SD</b>	SD Memory Card Media Player
<b>USB</b>	USB Flash Drive Media Player
<b>Settings</b>	Access Radio settings

Swipe left/right to access more apps

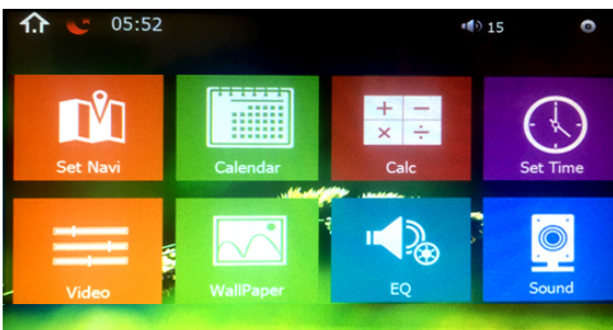

<b>*Set Navi</b>	Shortcut to set GPS map software file location
<b>Calendar</b>	Opens Calendar app
<b>Calc</b>	Opens Calculator app
<b>Set Time</b>	Shortcut to radio time setting
<b>Video</b>	Change display color/ contrast settings
<b>Wall Paper</b>	Change radio wall paper
<b>EQ</b>	Change EQ frequency settings
<b>Sound</b>	Front and rear balance settings

*\*Please Note:* GPS - Navigation and CD/DVD options and applications may only be found in select headunit receiver stereo systems, which include these, and other, additional/special features -- not all Pyle stereo models come equipped with GPS Navigation and/or CD/DVD players.

Visit [www.PyleAudio.com](http://www.PyleAudio.com) for more detailed information and more product specific information.

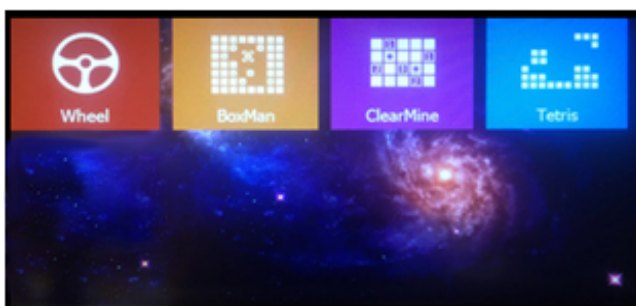

<b>Wheel</b>	Set steering wheel control presets
<b>BoxMan</b>	Game App
<b>ClearMine</b>	Game App
<b>Tetris</b>	Game App

## Settings

### 1) Scrolling

Use the red bar to scroll through the list of all available options.

### 2) Turn on/ off

Many settings can be toggled on or off in this screen

*\*Note: Factory setup is not adjustable by user. Do not attempt to enter this setup menu.*

## Set Time

### 1) Time Options

Turn GPS auto update and 12 hour clock settings on and off here.

Visit [www.PyleAudio.com](http://www.PyleAudio.com) to learn more about model specific information.

### 2) Date and Time

Use the up and down arrows to set the date and time accordingly.

## Sound

### 1) Fade/ Balance

Hold and drag left, right up or down to control the fade and balance of your audio output.

## Aux

Auxiliary input (rear RCA jacks) allow audio and video from external devices to be displayed or played through the unit. Auxiliary output (rear RCA jacks) allow audio and video to be sent out to external devices.

### 1) Customization – Use the settings to adjust and optimize the display quality.

Note: auxiliary app will display “No Signal” if no video signal is connected. Screen controls will not become active until external video signal is detected.



*\*The Parking brake will need to be wired to a grounding trigger to allow video pass through or a warning message will appear saying warning video disabled while driving.*



## Calendar

Displays the day, month and year.

Use forward and back arrows the view past or future months.

Selected dates are highlighted in blue

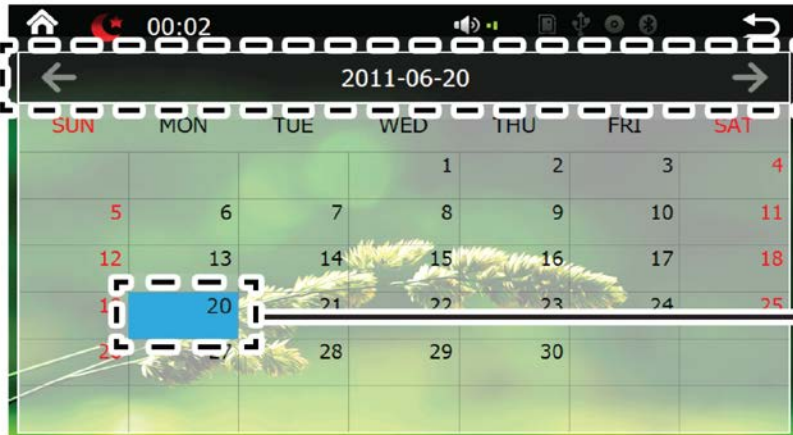

*Note: Calendar does not allow entry of appointments. Date must be set within system settings*

## Calculator

A handy little app for simple calculations

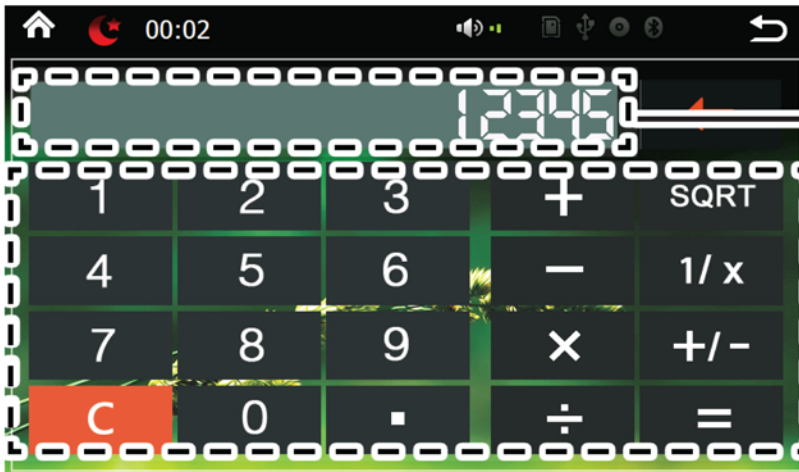

## EQ - Equalizer

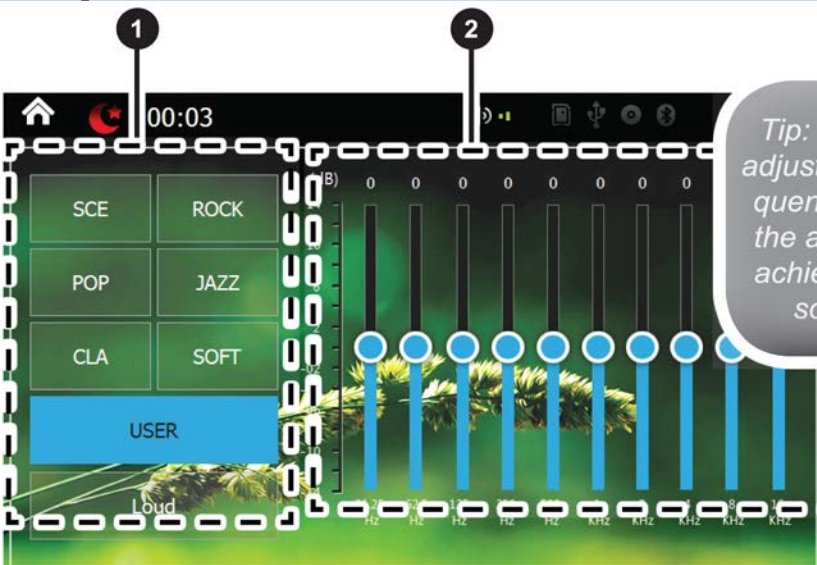

*Tip: Use the EQ to adjust the tone or frequency response of the audio system to achieve the desired sound quality.*

**Presets**  
*Select one to automatically adjust the equalizer*

**Adjustments**  
*Hold and drag up or down to manually adjust the EQ by each frequency band*

## Radio

- 1) Scanning: Press, hold, and drag the slider to quickly tune the radio.
- 2) Current Station: The currently selected station will be displayed in the center.  
Press the forward and back arrows to change the current station.
- 3) Favorite Stations: Press and hold one of the six preset slots to set and save a selection for later.

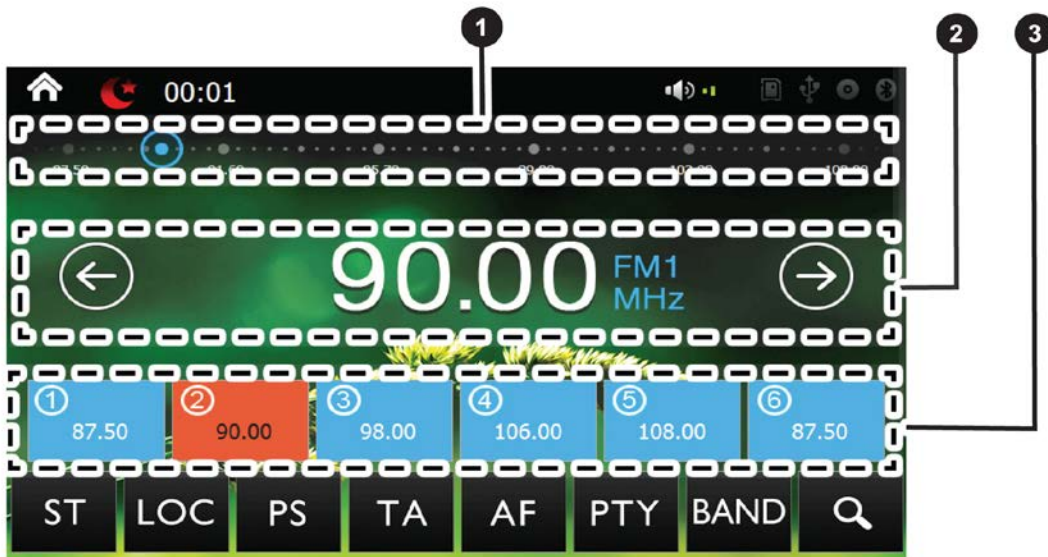

## SD - Flash Memory File Browsing

*Warning: Do not attempt to browse files while operating the vehicle*

### 1) Browsing Files

File location is displayed.

Use "Back Arrow" to return to the previous folder

### 2) Selecting Files

The files and folders of your storage media are displayed.

Once the desired folder is located, select it and press "check icon" to open

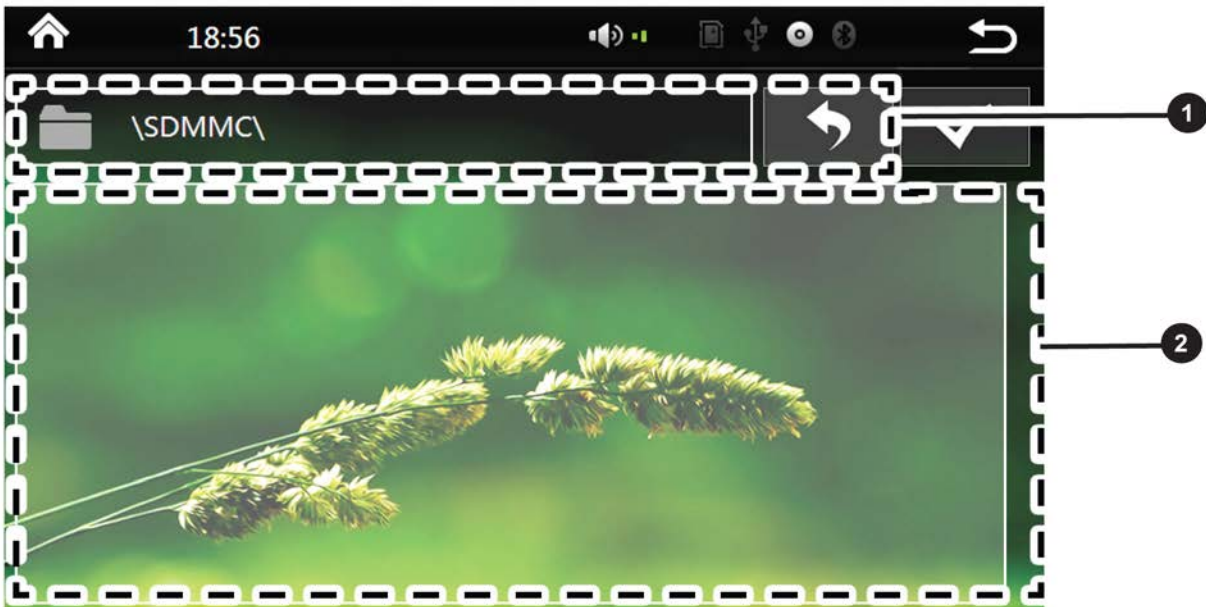

## USB - Flash Memory File Browsing

Plug in flash drives to access music video and photos.

## Video

1) Brightness, Contrast, Hue

Press, hold and drag to adjust the brightness, contrast and hue of the display.

2) Presets

Select to automatically adjust the display settings.

## Wall Paper

Note: Wallpapers can be imported from a flash drive or SD card. Check format sheet online for specs on formats.

1) Browse - Use left and right arrows to select the desired wallpaper

2) Select - Press OK to select the wallpaper

## Wheel

1) Steering Wheel Controls

Select the command in the application, then press the corresponding button on the wheel to teach the unit how to behave when steering wheel controls are used. To enter the steering wheel menu it will prompt you for a 4 digit pass code you will need to enter '0000'. Then you can manually program each desired option following the on screen instructions. *(Note: This feature is not compatible with all vehicle types).*

## Trouble Shooting

Q: Unit doesn't power up

A: Use a multi-meter to check for 12v+ to red and yellow wires. Check for proper Ground on the Black wire.

Q: My video does not play

A: Attach "PARK" wire to parking brake. When this wire is grounded the video will play (Grounding trigger of the parking brake)

Q: Reverse camera does not come up on the screen

A: Attach "BACK" wire to reverse tail light 12v+ (Make sure camera is and sending video signal)

Q: Can I set up steering wheel control?

A: Key 1 and Key 2 wires need to be wired to your vehicle's steering wheel column

Q: The time I set is not saved after device reboot

A: Are other setting saved? If not: Check that yellow memory wire is attached to 12v+ constant

A: turn off GPS auto update

-Go to radio settings > Set Time > switch off auto update

Q: My GPS gets no reception.

A: Check antenna is connected properly

A: Mount Antenna directly to your vehicle (GPS antenna is to be magnetically mounted, it will boost GPS reception when attached)

A: Check alternate antenna placement to test for interference

Q: How do I turn up GPS instruction volume (I Can't hear it over music)

A: Change GPS sound settings

Go to Navi > Settings > Sounds > Set GPS voice level to max > Set radio volume to min (Adjust accordingly)

Q: How do I update my map card.

A: The radio will notify you when a map update becomes available. We will need to send out a new map card from our parts department. Log onto [www.pyleaudio.com](http://www.pyleaudio.com) and open a parts ticket under "contact us" requesting the map update.

Q: Where can I download firmware updates?

A: This unit's hardware does not allow it to be updated with new OS or firmware.

Q: How do I access the Internet?

A: This device is not capable of receiving internet data.

Q: How to I set the time?

A: System setting, set time

## Trouble Shooting

Q: How do I use / set-up RDS?

A: (\*Traffic and weather feature only available in Europe)

Q: My Bluetooth microphone is not working as expected

A: -Check that nothing is covering microphone port.

-Check to see if closer proximity to the mic affects its pickup

-Check that phone connection is good

-Make sure the call recipient has speaker volume set to an appropriate level

-Check that the mic is not picking up too much background noise

Note: The built-in mic cannot be changed, replaced or upgraded.

Q: I am having trouble setting up Bluetooth

A: Check that your device is Bluetooth compatible 4.0+

- Check if you are able to pair with alternate devices via Bluetooth

- Clear out your device history in your Bluetooth setting menu and attempt to pair / connect again

Q: My Map card no longer loads (COCKPIT ERROR DISPLAYED)

A: This is caused by bug in map software. Please contact Tech Support: Pyle, [www.pyleaudio.com](http://www.pyleaudio.com) go to the "contact us" page.

A: You may be able to fix the software on your own

- Insert GPS card into computer

- Open text file under Primo\save\profiles\01\system.ini

- Edit the file to return the cockpit type to "1"

*\* Deleting the profile folder will default the unit's settings back to cockpit number 1*

Q: How do I play video files? My unit cannot read my digital video files.

A: Make sure SD card is compatible

A: Check file format of your file (You may need to convert your video file to an alternate file format)

Q: My unit shows 5 circles and will not load

A: Your unit requires touchscreen calibration.

You have entered the 'Touch Screen Calibration Menu'. For optimum touchscreen performance, this feature enables you to enjoy the best functionality of your device's touch screen. To complete the touchscreen calibration, an "X" will appear in the circles on the screen in numbered order, continue to press the center of the "X" as it passes through each numbered circle.

*(In circle number one, you will see an "X", touch the center of the "X", then the "X" will move to circle number two. Continue to touch the center of the "X" as it will move to the other circles in numbered order. If calibration senses an error, the process may restart; Repeat if necessary.)*

**PYLE®**  
PyleAudio.com

## Wiring - Back Panel:

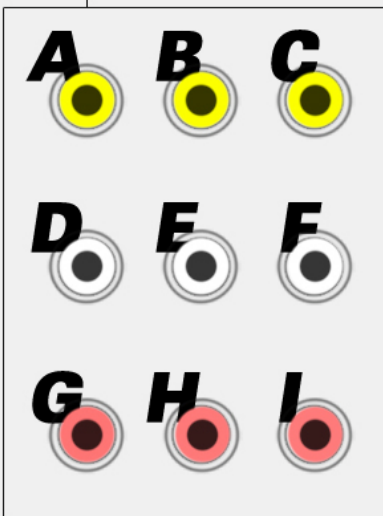
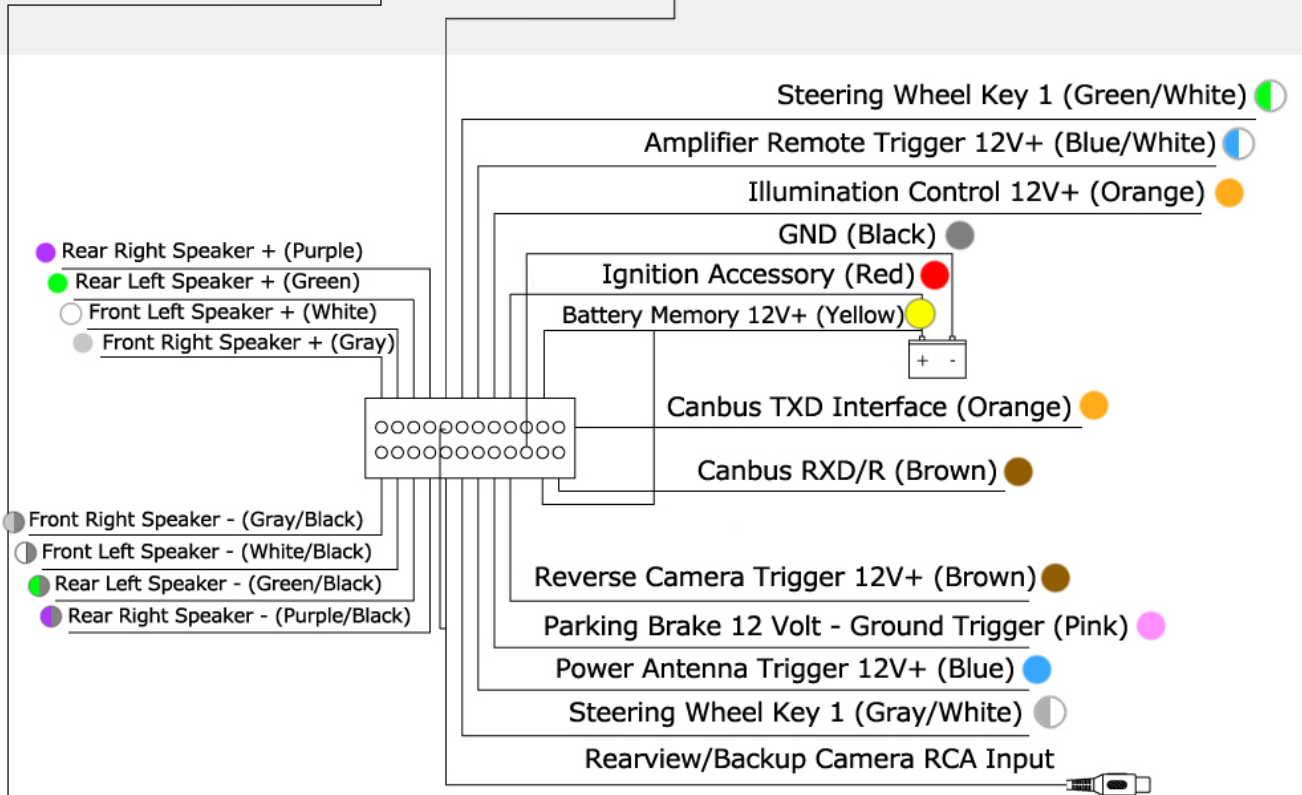
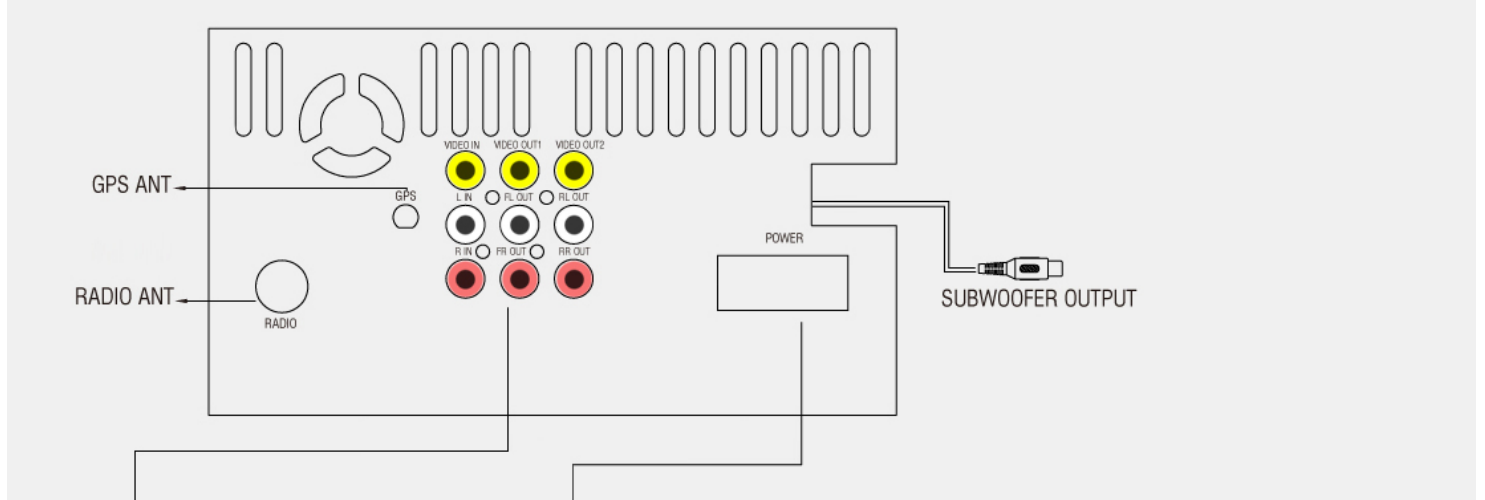

- A. Video Input
- B. Video Output 1
- C. Video Output 2
- D. Left Audio Input
- E. Front Left Audio Output
- F. Rear Left Audio Output
- G. Right Audio Input
- H. Front Right Audio Output
- I. Rear Right Audio Output



## Wiring - Color Wiring:

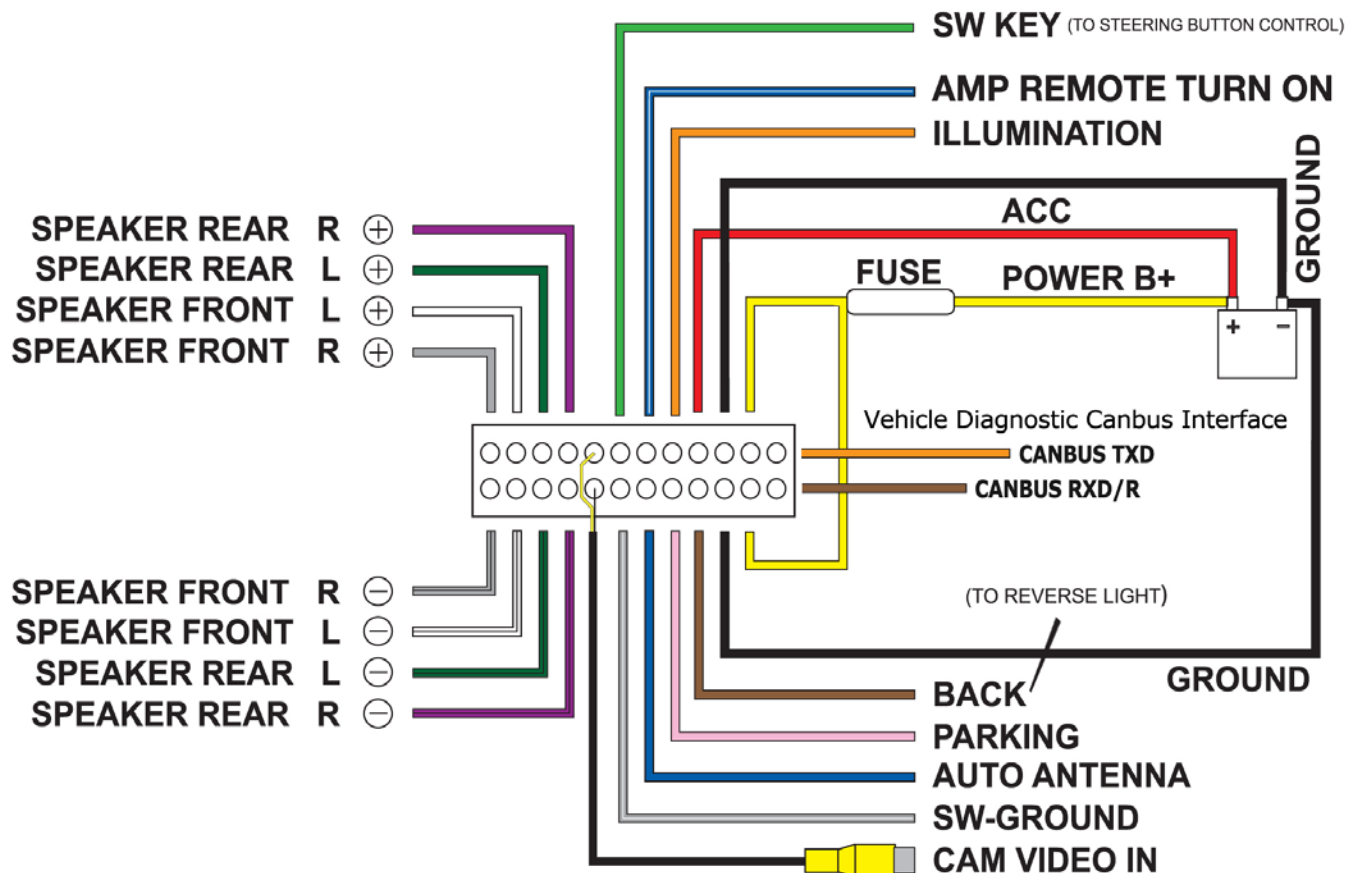

### Wiring

	Radio Antenna	Radio antenna receptacle		
	Subwoofer Output	Pre amp subwoofer output (5V)		
	Audio / Video Input	Auxiliary input for external hardware		
	Audio / Video Output 1	Connect to headrest display (Optional)		
	Audio / Video Output 2	Connect to headrest display (Optional)		
<b>Green/White</b>	SW KEY	Steering wheel control Key 1 interface wire		
<b>Blue/White</b>	AMP REMOTE TURN ON	DC 12 + Volt Remote turn on trigger for external amplifier		
<b>Orange</b>	ILLUMINATION	12 volt + trigger dash board illumination		
<b>Brown</b>	BACK	12 volt + trigger from reverse lights		
<b>Pink</b>	PARKING	Connect to parking brake ground. Disables video play unless grounded		
<b>Blue</b>	AUTO ANTENNA	12 volt + trigger output		
<b>Gray/White</b>	SW-GROUND	Steering wheel control Key 2 interface wire		
<b>Black (RCA)</b>	CAM VIDEO IN	Camera RCA video input for use with rearview camera		
<b>Red</b>	ACC	Ignition Accessory 12V+		
<b>Yellow</b>	FUSE/ POWER B+	Connect to (+) side of car battery		
<b>Black</b>	GROUND	Connect to (-) side of car battery		
<b>Orange</b>	CANBUS INTERFACE	TXD - Vehicle Diagnostic CANBUS Interface		
<b>Brown</b>	CANBUS INTERFACE	RXD/R - Vehicle Diagnostic CANBUS Interface		
<b>Purple</b>	Speaker Rear R	Rear right speaker	Purple (+)	Purple/Black (-)
<b>Green</b>	Speaker Rear L	Rear left speaker	Green (+)	Green/Black (-)
<b>Gray</b>	Speaker Front R	Front right speaker	Gray (+)	Gray/Black (-)
<b>White</b>	Speaker Front L	Front left speaker	White (+)	White/Black (-)

*\*Brown wire tells the monitor when to activate and display rearview camera on the display (optional)*

## DVD















DVD app will only open if a compatible DVD disc is detected.

### 1) Scrubbing

Press and drag along the time line to quickly skip through DVD times line.

(Note: DVD formatting does not allow scrubbing through previews and warnings)

### 2) Menu options & controls:

-  Return to the home screen.
-  Skip through the DVD chapters.
-  Pause and resume watching.
-  Stop the DVD.
-  Select chapter number by manually typing in the number.
-  Go to the next page of DVD menu options.
-  Return to the DVD main menu.
-  Rewind and fast forward.
-  Adjust playback audio settings.
-  Turn subtitles on/off.
-  Picture processor changes the display from dim to bright.
-  Return the main menu.
-  Zoom to make the picture bigger or smaller.
-  Repeat on/off.

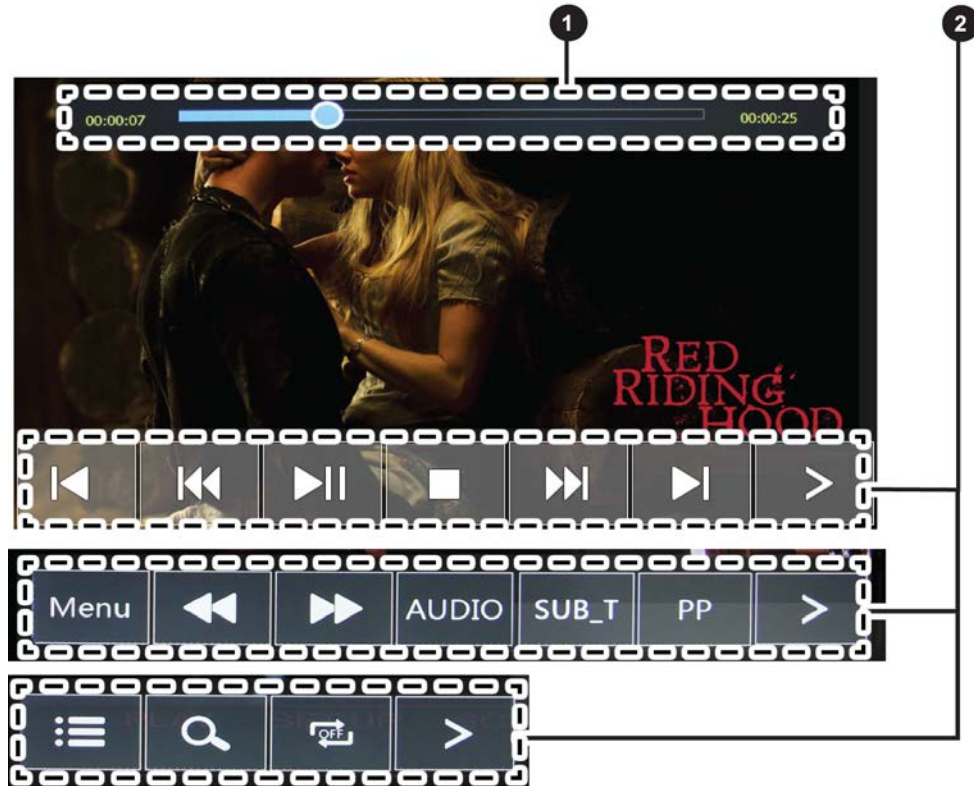

## Bluetooth

Bluetooth app allows Bluetooth pairing with compatible devices for making calls and music playback. To pair your phone, ensure Bluetooth is enabled in your phone's system settings and that you are disconnected from all other devices.

In the Bluetooth app of your radio, press the "Gear" icon in the left column to access Bluetooth settings. Next, press the "Magnifying glass" icon to set the radio into pair mode. The radio will then display "searching" and show all nearby compatible Bluetooth devices:

- Select your phone from the list, and tap a second time to initiate pairing.
- Your phone should now display a pin pad where you will enter "0000"
- Check that device named "CAR\_KITT" shows as connected on your phone.

*Note: Once your phone is paired, you can use the other functions within the radio's Bluetooth app.*

*Left hand column:*

- Select the "Keypad" icon to dial out using the radio's number pad
- Select the "address book" icon to display your phone's contact list. You will need to import your contact list using the "download" icon located in the right column of the Bluetooth app.
- Select the "phone" icon to see a log of incoming and outgoing calls
- Select the "gear" icon for phone pairing and selection options
- Select the "headphones" icon for music playback controls

*Right hand column:*

- "Trash" delete currently selected entry
- "Download" Use to download contact data to address book
- "Speaker selection" Switch between car speaker/mic and phone speaker/mic

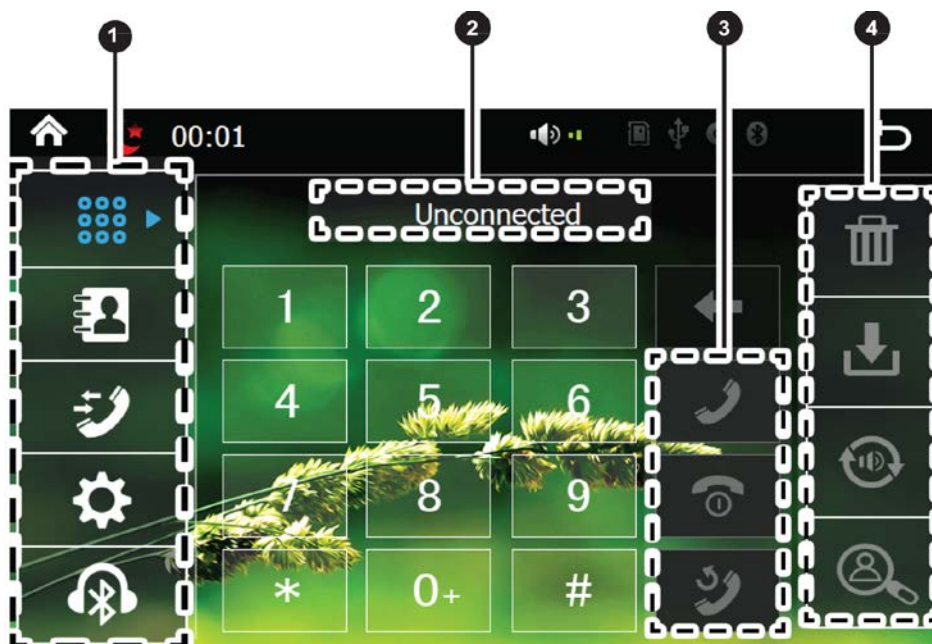

1600 63rd. Street Brooklyn N.Y. 11204

**PYLE<sup>®</sup>**

[PyleAudio.com](http://PyleAudio.com)

