

# PYLE

PyleUSA.com



**PLR2DN**

**Stereo Receiver Power Amplifier**

AM/FM/MP3/BT/USB/AUX, Stereo Receiver, Double DIN,  
30 Preset Memory Stations, LCD Display with Remote Control



**PLMR2DNBK**

**Marine Stereo Receiver Power Amplifier & Speaker Kit**

AM/FM/MP3/BT/USB/AUX, Marine Stereo Receiver, Double DIN,  
30 Preset Memory Stations, LCD Display with Remote Control  
and 1 Pair of PLMR60B



**PLMR3DNWT**

**Marine Stereo Receiver Power Amplifier & Speaker Kit**

AM/FM/MP3/BT/USB/AUX, Marine Stereo Receiver, Double DIN,  
30 Preset Memory Stations, LCD Display with Remote Control  
and 1 Pair of PLMR60W

**USER GUIDE**

**To ensure correct operation and avoid damage,  
please read this user manual carefully before using this product.**

## **INSTALLATION**

### **Installation Procedures**

First complete the electrical connections and then check for correctness.

### **Installation Opening**

This unit can be installed in any dashboard having an opening as shown below.

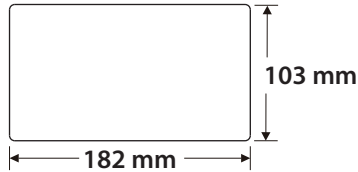

### **To Install the Car Radio**

**Be sure you test all connections first, and then follow these steps to install this unit.**

1. Make sure the ignition is turned off, and then disconnect the cable from the vehicle battery's negative (-) terminal.
2. Disconnect the wire harness and the antenna.
3. Attach the "L" brackets (2pcs) on the both sides of the car receiver with screws (M5.5 x 7) as shown as the below figure. The others fixing screws that fix the other terminal of the "L" metal bracket, please buy from your dealer according to the drilling of holes size.

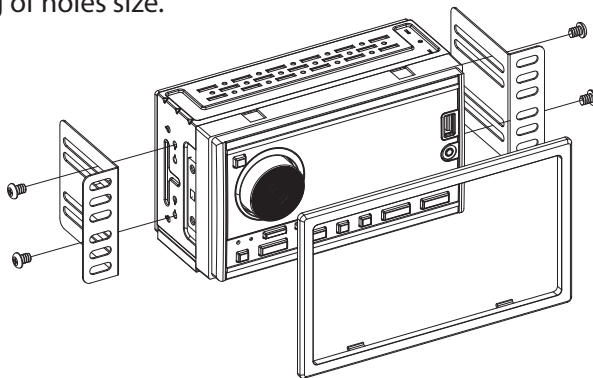

4. Consult with you nearest dealer if installation requires the drilling of holes or other modifications of the vehicle.
5. Install this car receiver in the dashboard.
6. Make wiring connections, as illustrated in the "Wiring Diagram."
7. Install the plastic outer trim ring.

# INSTALLATION

Connect all wiring harness and slide the head unit into the mounting collar until it clicks into place.

## Wiring Connections

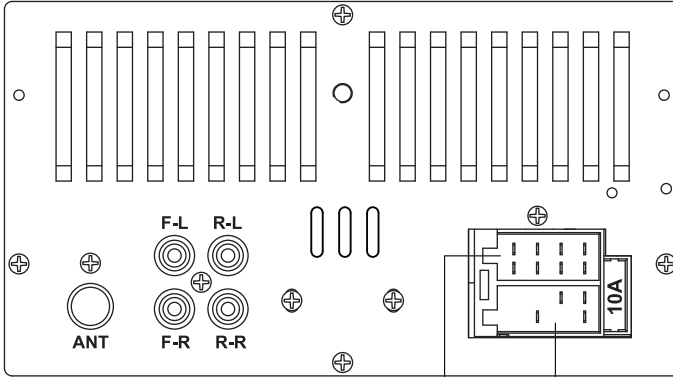

**ANT:** Radio Antenna Socket

**FL:** Front Left Pre-Amp RCA Output (White)

**FR:** Front Right Pre-Amp RCA Output (Red)

**RL:** Rear Left Pre-Amp RCA Output (White)

**RR:** Rear Right Pre-Amp RCA Output (Red)

**10A:** 10A Fuse

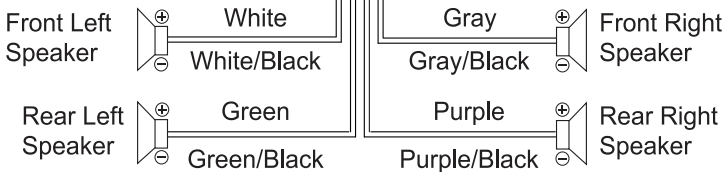
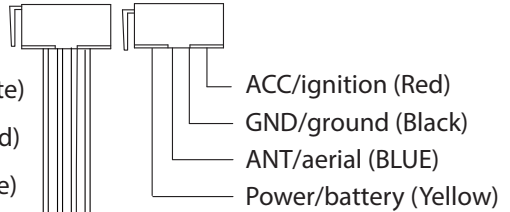

- +12V DC Negative Ground.
- Only use speakers with 4 ohms impedance.
- The maximum current of the Amp remote trigger is 200mA.

## OVERVIEW OF THE CONTROLS

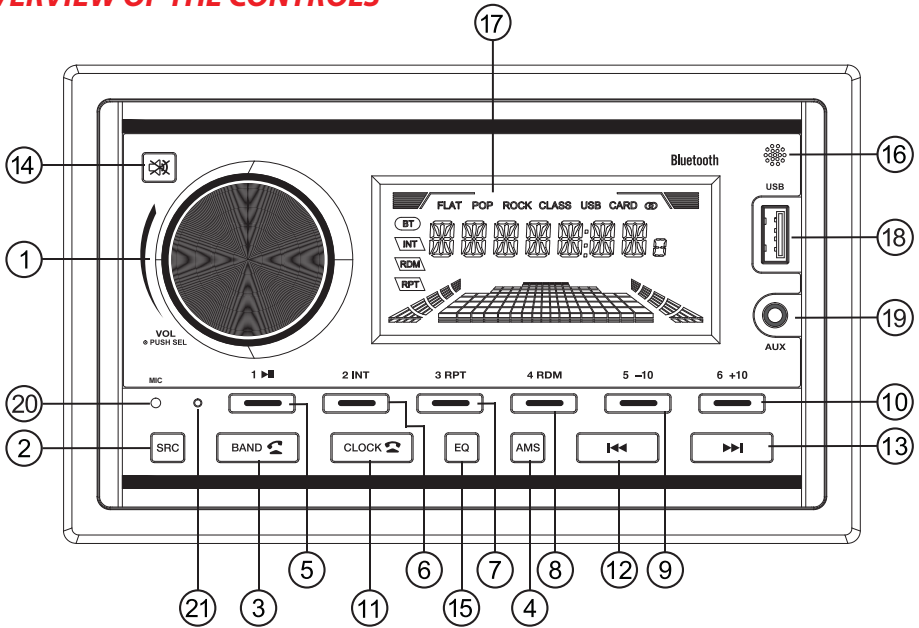

1. **⏻** (power)/Volume knob and SEL (select/menu) button
2. **SRC** (source) button
3. **BAND** (band) button, **☎** (answer call) button
4. **AMS** (automatic store/preset station scan, automatic music search) button
5. **⏸** (pause/play), Preset station 1 button
6. **INT** (intro), Preset station 2 button
7. **RPT** (repeat), Preset station 3 button
8. **RDM** (random), Preset station 4 button
9. **-10** (previous 10 tracks), Preset station 5 button
10. **+10** (next 10 tracks), Preset station 6 button
11. **CLOCK** (clock setting) button, **☎** (end call) button
12. **⏮** (tune down, seek down, previous, fast reverse) button
13. **⏭** (tune up, seek up, next track, fast forward) button
14. **⊘** (MUTE) button
15. **EQ** (Equalizer)
16. **IR** remote sensor
17. **LCD** Display
18. **USB** Port
19. **AUX IN** (auxiliary input) jack
20. **Hands-free Microphone**
21. **Reset** button

## GENERAL OPERATION

### Turn Unit ON/OFF, Change the Source

- Press any button to turn on the unit.
- Press the power (⏻) button to turn the unit off.

### Adjust the volume (VOL)

Rotate the **VOL** knob on the front panel or press the **VOL+** ▲ / **VOL-** ▼ button on the remote control to increase or decrease the volume level.

### Adjust Menu Options (SEL)

- Press the **SEL** button on the front panel or on the remote control repeatedly to cycle through the following adjustable audio functions: BASS, TREBLE, BALANCE, FADER, EQ OFF, CLASS/ROCK/POP/ FLAT, LOUD ON/OFF, DX/LOC, STEREO/MONO, CLOCK 12/24, AREA US/EU, AUTO/BLUE/RED/CYAN/GREEN/PURPLE/YELLOW/WHITE.
- Rotate the **VOL** knob on the front panel or press the **VOL+** ▲ / **VOL-** ▼ button on the remote control to adjust the selected item.
  - **BASS/TREBLE:** -7, -6, ~, -1, 0, +1, ~, +6, +7
  - **BALANCE:** L7, L6, ~, L1, 0, R1, ~, R6, R7
  - **FADER:** R7, R6, ~, R1, 0, F1, ~, F6, F7
  - **EQ (Equalizer) Setting:** OFF, CLASS, ROCK, POP, FLAT
  - **Loudness:** LOUD ON/OFF
  - **DX/LOCAL:** Enables or disables the local broadcast mode (LOCAL).
  - **Stereo/Mono:** Switches between **MONO** and **STEREO** reception mode for radio frequencies.
  - **CLOCK 12/24:** Select between 12 hours and 24 hours display.  
**Note:** If 12 hour display is selected, AM= Morning; PM= Afternoon
  - **AREA US/EU:** This car radio is equipped the USA / Europe frequency.  
Rotate the volume knob to switch between USA and Europe frequency.  
The system will change the frequency setting in about 3 seconds.
  - **7 color-changing illumination in buttons:**  
This car radio device is equipped 7 color-changing illumination in buttons.  
The illumination color can be preset Auto (color automatically change one by one), Blue, Red, Cyan, Green, Purple, Yellow, White.

## Setting the Clock (CLOCK)

1. To display clock time, press the **CLOCK** button.
2. To set clock time, press and hold the **CLOCK** button and the hour digits will flash on the display.
3. Rotate the **VOL** knob to adjust the hour.
4. Press the **CLOCK** button again, the minute digits will flash on the display.
5. Rotate the **VOL** knob to adjust the minute.
6. Press the **CLOCK** button to confirm time settings.

## Change the Source (MODE)

Press the **SRC** button to switch between RADIO, USB (with USB device inserted), AUX-IN (auxiliary input) and BT modes.

## Mute ON/OFF

In power on mode, briefly press the **MUTE** button to toggle mute on or off.

## USB Port

The USB port of this car radio is designed for media playback from flash memory devices and charging for iPhone/android mobile phone. The USB port also support USB charging, the charging ability is 5V/1A.

## AUX IN (Auxiliary Input) Jack

## Reset Button

Push the **RESET** button with a thin object with a pointed end to reset the unit.

## **RADIO OPERATION**

### Switch Between USA area and Europe area Frequency

In radio mode, press the SEL button to enter the switch state of the EU (europe) and US(USA) frequency, then rotate it to switch between EU and US (USA) frequency. The system will change the frequency setting in about 3 seconds.

### Change Bands

In radio mode, shortly press the **BAND** button to switch between the FM1 (F1), FM2 (F2), FM3 (F3), AM1(A1), AM2 (A2) bands.

## To Store/Recall Preset Stations

The radio can be stored 6 preset stations for each band (FM1, FM2, FM3, AM1 and AM2) for a total of 30 preset stations.

- **To memorize a station:** Press and hold the desired preset buttons (1-6) to save a radio station.
- **To recall a preset station:** Briefly press the respective station button (1-6) to recall the corresponding preset station.

## Manual Tuning

### In the radio mode:

Press and hold the ►► or ◀◀ button to enter the manual tuning mode.

In manual tuning mode, briefly press the ►► or ◀◀ button to search the next or previous frequency step by step.

## Seek Tuning

In radio mode, press the ►► or ◀◀ button, the automatic search will start, it will search upward or downward for the strong signal radio station within the current band. The auto searching will stop until it finds a station.

## Automatic Store Preset station (AMS)

Press and hold the **AMS** button to store 18 FM and 12 AM preset stations automatically.

## Automatic Preset Scan

Briefly press the **AMS** button to recall each preset station that is stored in the memories in each band.

## LOCAL/DX

Press the **LOC** button on the remote control to choose local or distant reception mode.

## STEREO/MONO

Press the **ST** button on the remote control to choose **FM STEREO** or **MONO** audio effect.

## **USB OPERATION**

### **To insert USB**

- Play MP3/WMA music inside a USB stick. Insert the USB stick with MP3/WMA musics into the USB port, it will play automatically.
- The USB port also support USB charging, the charging ability is 5V/1A.

### **Select Next Track or Previous Track**

In the USB mode, briefly press the ►► or ◀◀ button to play the next or previous track.

### **Fast Forward/Reverse**

Press and hold the ►► or ◀◀ button to fast forward or reverse a track.

### **Play/Pause**

Press the ►|| button to interrupt the playback of a music (pause function).

Press this button again to continue the playback.

### **Introduction Scan**

Press the **INT** button to play the first 10 seconds of all track.

Press again to stop the introduction scan, and play the current track.

### **Repeating the track**

Press the **RPT** button to toggle between RPT ALL (Play all track), RPT ONE (Continuously repeat current track) and RPT FLR (Continuously repeat all tracks in current folder).

### **Playing all tracks in random**

Press the **RDM** button. A random playback of all tracks will start.

Press the button again to set the normal playback.

### **Track/Folder Navigation**

- Press the **-10/+10** buttons to jump 10 tracks backward or forward.
- Press and hold the **-10/+10** button to select the previous or the next folder.



## Select the track or file for playback in MP3 format

- a. Press the **AMS** button to enter track search mode.  
First "TRK0000" will appear on the display.
- b. Rotate the **VOL** knob to select the number of your favorite track with high speed.
- c. When the desired track number appears, confirm your selection by pressing **SEL** button. If no any operation in 5 seconds, it will play the current track.



## **WIRELESS BT STREAMING OPERATION**

### Pair and Connect

Before using a Wireless BT device for the first time, it must be paired and connected.

1. This head unit broadcasts the pairing signal constantly when no devices are connected. User can complete the pairing steps from your Wireless BT device. Refer to owner's manual for your device for more details.
2. When the phone finds the car audio system, the "**Pyle**" name will be displayed. Choose the "**Pyle**" from the device list to pair and connect with the car audio system. Upon confirming, the BT logo will stop flashing.



### Making a Call

- To make a call, dial the call directly from the paired mobile phone.
- **To make a call with this bluetooth handsfree system:**
  - a. When linking up the Wireless BT enabled mobile phone to this BT handsfree system, press the  button to access the dial telephone number mode. Then press the "0~9", \*and # button on remote control to input the telephone number, the entered number will be shown on the LCD display.
  - b. If a number has been incorrectly inputted, press the  button or press the **DEL** button on the remote control to delete it.
  - c. Press the  button to make outgoing call.

### Answer a Call

When the mobile phone is called, the incoming telephone number displays on the LCD display. Press the  button on front panel or the button on the remote control to answer the incoming phones.

### **Redial Last Dialed Number**

Press and hold the  button on the front panel or  button on the remote control to redial the last dialed phone number.

### **Reject or End a Call**

Press the  button on the front panel or  button on the remote control to reject or end the call.

### **Switch Audio Between Car Audio and mobile Phone**

During a call, press the **VOL** knob/button to switch the audio source from the car audio system back to your mobile phone.

### **Adjust Call Volume**

During a talk, use **VOL** knob or **VOL+**  / **VOL-**  button to adjust the call volume level.

### **Audio Streaming (A2DP)**

This head unit supports A2DP (advanced audio distribution profile) wireless streaming audio from a Wireless BT mobile device directly to your head unit.

The following functions can be used to control the music playback.

#### **• Skip to Next music**

Press the  button to play the next music in the mobile phone.

#### **• Skip to Previous music**

Press the  button to previous music in the mobile phone.

#### **• PLAY/PAUSE**







Press the  button to pause or restore the music playback.

### **AUXILIARY OPERATION**

Using this socket, it is possible to hear the sound of other playback devices such as MP3 players, CD players etc. through the car loudspeaker.

1. Please connect the external device with a 3.5 mm stereo jack plug to the AUX socket.
2. Press the **MODE** button repeatedly until "**AUX IN**" appears in the display.
3. You hear the playback from the external device via the loudspeakers.  
You can adjust the volume of the external device to a comfortable level with the volume control of this device.

## REMOTE CONTROL

1.  (Power on/off) button
2. **SEL** (Audio/Menu) button
- 3/15.  (Tune down, seek down/Track down, Fast reverse) button.  
 (Tune up, seek up/Track up, Fast forward) button
- 4/14. **VOL+** (volume increase) button, **VOL-** (volume decrease) button
5. **MUTE** button, **DEL** (Delete) button
6. **INT** (intro), Preset station 2, Keypad 2
7.  (pause/play), Preset station 1, Keypad 1
8. **-10** (previous 10 tracks), previous folder, Preset station 5, Keypad 5
9. **RDM** (random), Preset station 4, Keypad 4
10. **LOUD** (Loudness), Keypad 8
11. **STEREO/MONO**, Keypad 7
12. **MODE** button, Keypad \*
13. **Band** button,  (answer call) button
16. **CLK** (Clock setting),  (end call) button
17. **RPT** (repeat), Preset station 3, Keypad 3
18. **+10** (next 10 tracks), next folder, Preset station 6, Keypad 6
19. **AMS** (auto store / preset station scan, auto music search), Keypad 9
20. **EQ** (Equalizer Preset) , Keypad #0
21. **LOC** (Local)/DX (Distant) Reception, Keypad #

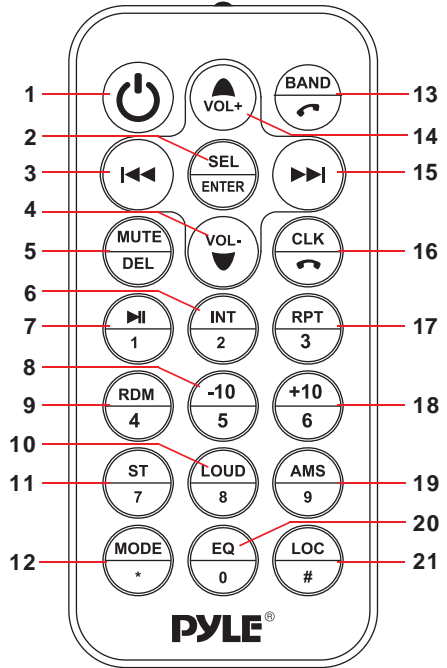

### Note:

When using the remote control for the first time, you must pull out the protective plastic tab from the battery compartment found on the back of the remote control.



WARNING:

This product can expose you to a chemical or group of chemicals, which may include "Di (2-ethylhexyl) phthalate (DEHP)" which is known in the state of California to cause cancer, birth defects, or other reproductive harm. For more info, go to <https://www.p65warnings.ca.gov/>.

## **PLR2DN**

### **Stereo Receiver Power Amplifier**

AM/FM/MP3/BT/USB/AUX, Stereo Receiver, Double DIN, 30 Preset Memory Stations, LCD Display with Remote Control

#### **Features:**

- AM/FM/MP3/BT/USB/AUX Stereo Receiver
- Double DIN
- LCD Display with Remote Control
- AM/FM Stereo Radio, 30 Station Memory
- Wireless BT Audio Ability
- Front Aux-in, Front USB, No SD Card Reader
- Aux (3.5mm) Input Connector Jack
- Connect & Stream Audio from External Devices
- MP3 Digital Audio File Playback
- LCD Display Black Panel
- Electronic Volume Control (Treble, Bass, Balance, Fader)
- Memory/Repeat/Random/Intro Play
- EQ / Mute / Clock Control, English ID3
- ID3 Tag Song Readout for Artist Name/Song Title
- VA LCD/White Back-Light, Night Illumination: RGB
- 2 Pair RCA Output, ISO Connector Line Out
- Equalizer (EQ) Electronic Audio Configuration
- Automatic Memory Preset Store/Scan Mode
- Repeat/Random Song Functions

#### **Technical Specs:**

- Remote Control Battery Operated, Requires (1) Coin-Type Battery
- Battery Type: 3V Lithium Bat. 240mAh Capacity
- Night illumination: RGB
- MAX. Power: 4x75W (300 Watts)
- PLL Electronic Tuning Radio Tuner
- ISO with 4 Pin/8 Pin Wire Connector
- Stereo/Mono Mode Selectable
- Audio Control: Treble, Bass, Balance, Fader
- Preset EQ: Flat/Pop/Rock/Class/Jazz/Off
- Switchable USA/Europe Tuner Frequencies by Software
- Max. USB Support: 64GB
- Power: DC 12V
- Current Consumption: 10A
- Product Dimension: 2.7" x 7.1" x 3.9" - inches

## **PLMR2DNBK**

### **Marine Stereo Receiver Power Amplifier & Speaker Kit**

AM/FM/MP3/BT/USB/AUX, Marine Stereo Receiver, Double DIN, 30 Preset Memory Stations, LCD Display with Remote Control & 1 Pair of PLMR60B

#### **Features:**

- AM/FM/MP3/USB/AUX Marine Stereo Receiver
- Black Panel with 1 Pair of PLMR60B
- Double DIN
- LCD Display with Remote Control
- Marine Stereo Receiver System
- AM/FM Stereo Radio, 30 Station Memory
- Wireless BT Audio Ability
- Aux (3.5mm) Input Connector Jack
- Connect & Stream Audio from External Devices
- MP3 Digital Audio File Playback
- LCD Display Panel
- Front Aux-in, Front USB, No SD Card Reader
- Electronic Volume Control (Treble, Bass, Balance, Fader)Memory/Repeat/Random/Intro Play
- EQ / Mute / Clock Control, English ID3
- ID3 Tag Song Readout for Artist Name/Song Title
- VA LCD/White Back-Light, Night Illumination: RGB
- 2 Pair RCA Output, ISO connector Line Out
- Equalizer (EQ) Electronic Audio Configuration
- Automatic Memory Preset Store/Scan Mode
- Repeat/Random Song Functions

#### **Technical Specs:**

- Remote Control Battery Operated, Requires (1) Coin-Type Battery
- Battery Type: 3V Lithium Bat. 240mAh Capacity
- Night illumination: RGB
- MAX. Power: 4 x 75W (300 Watts)
- PLL Electronic Tuning Radio Tuner
- ISO with 4 Pin/8 Pin Wire Connector
- Stereo/Mono Mode Selectable
- Audio Control: Treble, Bass, Balance, Fader
- Preset EQ: Flat/Pop/Rock/Class/Jazz/Off
- Switchable USA/Europe Tuner Frequencies by Software
- Max. USB Support: 64GB
- Power: DC 12V
- Current Consumption: 10A
- Product Dimension: 2.7" x 7.1" x 3.9" - inches

## **PLMR3DNWT**

### **Marine Stereo Receiver Power Amplifier & Speaker Kit**

AM/FM/MP3/BT/USB/AUX, Marine Stereo Receiver, Double DIN, 30 Preset Memory Stations, LCD Display with Remote Control & 1 Pair of PLMR60W

#### **Features:**

- AM/FM/MP3/USB/AUX Marine Stereo Receiver
- Double DIN
- White / Grey button Panel, with 1 Pair PLMR60W
- LCD Display with Remote Control
- Marine Stereo Receiver System
- AM/FM Stereo Radio, 30 Station Memory
- Wireless BT Audio Ability
- Aux (3.5mm) Input Connector Jack
- Connect & Stream Audio from External Devices
- MP3 Digital Audio File Playback
- LCD Display Panel
- Front Aux-in, Front USB, No SD Card Reader
- Electronic Volume Control (Treble, Bass, Balance, Fader)Memory/Repeat/Random/Intro Play
- EQ / Mute / Clock Control, English ID3
- ID3 Tag Song Readout for Artist Name/Song Title
- VA LCD/White Back-Light, Night Illumination: RGB
- 2 Pair RCA Output, ISO connector Line Out
- Equalizer (EQ) Electronic Audio Configuration
- Automatic Memory Preset Store/Scan Mode
- Repeat/Random Song Functions

#### **Technical Specs:**

- Remote Control Battery Operated, Requires (1) Coin-Type Battery
- Battery Type: 3V Lithium Bat. 240mAh Capacity
- Night illumination: RGB
- MAX. Power: 4 x 75W (300 Watts)
- PLL Electronic Tuning Radio Tuner
- ISO with 4 Pin/8 Pin Wire Connector
- Stereo/Mono Mode Selectable
- Audio Control: Treble, Bass, Balance, Fader
- Preset EQ: Flat/Pop/Rock/Class/Jazz/Off
- Switchable USA/Europe Tuner Frequencies by Software
- Max. USB Support: 64GB
- Power: DC 12V
- Current Consumption: 10A
- Product Dimension: 2.7" x 7.1" x 3.9" - inches



PLR2DN

**What's in the Box:**

- Stereo Receiver
- ISO 4 Pin Power & 8 Pin Speaker Wiring Harness
- Outer Trim frame Cover
- Remote Control



PLMR2DNBK

**What's in the Box:**

- Stereo Receiver
- ISO 4 Pin Power & 8 Pin Speaker Wiring Harness
- Outer Trim frame Cover
- 1 Pair of Marine Grade Speakers PLMR60B
- Remote Control



PLMR3DNWT

**What's in the Box:**

- Stereo Receiver
- ISO 4 Pin Power & 8 Pin Speaker Wiring Harness
- Outer Trim frame Cover
- 1 Pair of Marine Grade Speakers PLMR60W
- Remote Control

**WIRELESS BT CONNECTIVITY:**

- Built-in BT for Wireless Music Streaming
- Built-in Microphone for Hands-Free Calling
- Conveniently Reject/Answer Incoming Calls
- Compatible with All of Your Favorite Wireless BT Devices (iPhone, Androids, Smartphones, iPad, Tablets, etc.)
- Wireless BT Version: 4.2

# PYLE

PyleUSA.com



**VISIT US ONLINE:**

*Have a question?*

*Need service or repair?*

*Want to leave a comment?*

[PyleUSA.com/ContactUs](http://PyleUSA.com/ContactUs)

PYLE

## ***Questions? Issues?***

We are here to help!

Phone: (1) 718-535-1800

Email: [support@pyleusa.com](mailto:support@pyleusa.com)