

# PYLE

PyleUSA.com



**PLMRB38B**



**PLMRB39W**



**PLMRK47BK**



**PLMRKT49WT**

Marine Stereo Receiver Power Amplifier  
AM/FM/MP3/USB/AUX/SD Card Reader Marine  
Stereo Receiver, Single DIN, 30 Preset Memory Stations,  
LCD Display with Remote Control

## USER MANUAL

## INSTALLATION

### Preparation

The preparation kit is necessary to mount the radio on the dashboard, this kit is available at electronics stores and car audio specialists, check the installation kit before using it to make sure it is the right one for your vehicle.

### INSTALL THE DEVICE

1. Lift the left or right top corner of the plastic outer trim ring then pull it out to remove it.
2. Insert the two bracket keys into the left and right side of the chassis to separate the chassis from the housing.
3. Install the mounting knob on the board. Check the opening size of the sliding panel to be mounted. If the measurement is not large enough, carefully cut it until it slips easily on the opening. Do not force the handle in the opening so as not to bend it. Locate the series of dubbing tabs above, below and all sides to be mounted. Completely insert it to the opening of the board, bend the tabs as necessary towards outside to ensure it fits the board.
4. Slide the stereo into the opening in the dash, ensuring that the wires behind are tucked and not pinched.
5. Follow the wiring diagram carefully.  
Verify you've connected them correctly.  
**CAUTION!** Connect the unit to a 12 Volt power source with adequate ground.
6. Now that your wires are all completed, attach the front panel and turn **ON** the unit (the vehicle must be switched on). If the unit does not work, check the calibration again until the problem is solved. With the new car stereo secured into the bracket, all you need to do is plug the wiring harness back into the stereo and put the assembly back into place.
7. Slide the stereo into the opening in the dash, ensuring that the wires behind are tucked and not pinched. Sometimes this may take a few times when the vehicle has a tight dash opening. Tuck the wires back into an opening behind the unit.
8. Install the plastic outer trim ring
9. Snap all the pieces of trim back into place over the stereo. Double check that all screws and trim pieces are securely in place. Try out the new stereo. Turn the car power on again and play around with the stereo and its settings to be sure everything is in working order.

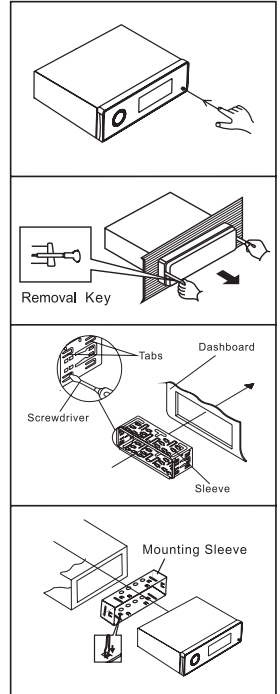

## WIRING CONNECTIONS

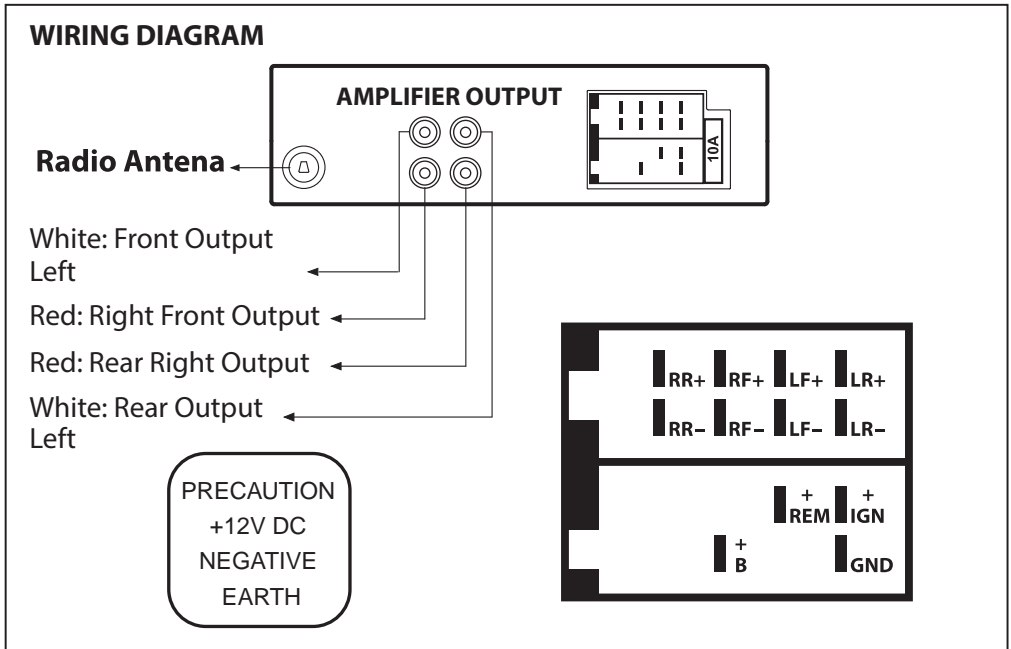

## CONTROL PANEL BUTTONS

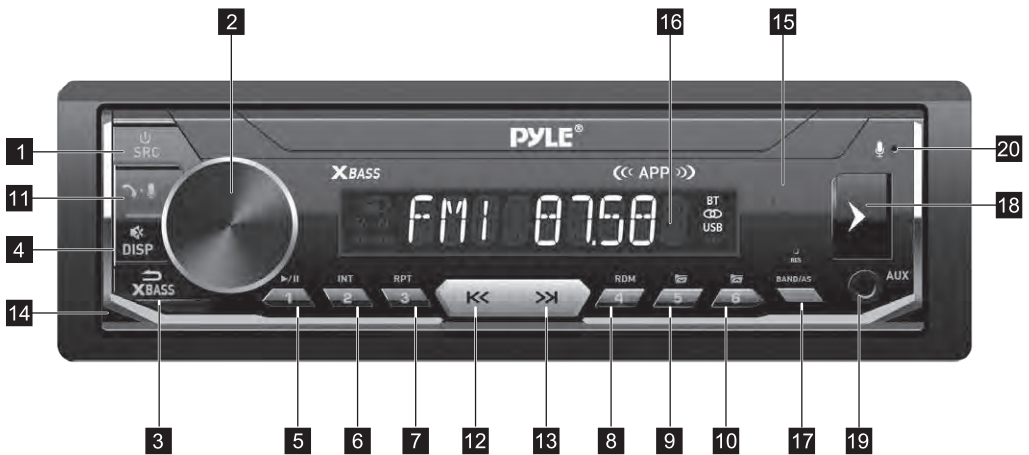

## CONTROL PANEL BUTTONS

1. **⏻** (Power)/MODE (source) button
2. **SEL** (select/menu) button and **VOL** (volume) knob
3. Back to the previous configuration point  
Press **↩**/Bass enhances the pulse function
4. **🔊** In power on mode, press the **MUTE** button to toggle mute **ON** or **OFF**.  
/DISP (CLK) button
5. **⏸** (pause/start), Button 1 preset station
6. **INT** (intro), Station preset button 2
7. **RPT** (repeat), button 3 preset
8. **RDM** (random), button 4 preset
9. **-10** (10 following songs), preset station 5 button
10. **+10** (10 following songs), preset button 6 station
11. **📞** Phone button
12. **⏮** (tune back, search back, crawl back, fast reverse)
13. **⏭** (tune forward, search forward, crawl forward, fast forward)
14. **Release** button cover
15. **IR** remote control sensor
16. **LCD** screen
17. **BAND** (band) button/**AS**  
(automatic storage/preset station search, automatic search)
18. **USB/SD** port
19. **AUX IN** (auxiliary input)
20. **MIC** hole (integrated microphone)

## GENERAL OPERATION

### Turn Unit ON/OFF

- Press the power **⏻**/**MODE** button on the front panel to turn **ON** the unit, and press and hold it again to turn **OFF** the unit.
- Press the power **⏻** button on the remote control to turn the unit **ON** or **OFF**.

### Adjust Volume (VOL)

- Rotate the **VOL** knob on the front panel or press the **VOL+ ▲**/**VOL- ▼** button on the remote control to increase or decrease the volume level.

### Adjust Menu Options (SEL)

- Press the **SEL** button on the front of the panel or on the remote control repeatedly to navigate through the following audio functions: BASS (Low), TREBLE (treble), BALANCE (Balance), FADER (attenuate), EQ (Equalizer) OFF (off), CLASS (classic)

ROCK/POP/FLAT (flat), LOUD ON/OFF (volume), DX/LOC, STEREO/MONO, CLOCK 12/24, BLUE/RED/CYAN/GREEN/PURPLE/YELLOW/WHITE/AUTO.

Turn the **VOL** knob on the front panel or press the **VOL+ ▲ /VOL- ▼** button on the remote control to set the selected item. Press **SEL** button to select **SWE** (subwoofer) Rotate the knob to select **ON/OFF**

- Press SEL button then press band button get into 10EQ control mode. Press band button to select EQ volume then turn volume knob to select EQ level.
- BALANCE (Balance): L7, L6, ~, L1, 0, R1, ~, R6, R?
- FADER (attenuate sound): R7, R6-, R1,0, F1, ~, F6, Fr
- EQ (Equalize) Set: OFF, CLASS, ROCK, POP, FLAT,JAZZ,COUNTRY.
- Loudness (reduce sound): LOUD ON / OFF.
- DX/LOCAL: Enables or disables the local broadcast mode (LOCAL).
- Stereo/Mono: change the reception mode STEREO or MONO in Radio.
- CLOCK 12/24: Changes the clock format between 12 and 24 hrs.
- Change buttons of 7 color in the lighting:  
Preset as blue, red, clan, green, purple, yellow, white or Auto (the color changes automatically one by one).

### Set the clock (DISP) (CLK)

1. To display the Time press the **CLK** button.
2. To set the time, press and hold the **CLK** button and the time will start flashing.
3. Press the **◀◀** or **▶▶** button on the front panel or on the remote control to set the time.
4. Press the **CLK** button and the minutes will start flashing.
5. Press the **◀◀** or **▶▶** button on the front panel or on the remote control to set the minutes.

### Change the source mode (MODE)

Press the **MODE** button to switch between the button **RADIO**, **BT** (Bluetooth), **USB** (with a USB device inserted), **SD** (with SD card inserted) and **AUX-IN** mode (input assistant).

### Mute ON/OFF

In power on mode, briefly press the **MUTE** button to mute or continue. The silent state will be released when the volume knob is used.

### Loudness: LOUD ON/OFF

Press the **LOUD** button on the remote control to change the loud volume to boost the bass output frequency, press again, to turn it off.

## **GENERAL OPERATION**

### **Preset Equalizer (EQ)**

Press the **EQ** button on the front panel or on the remote control to switch between EQ, OFF, CLASS, ROCK, POP, FLAT.

### **USB port**

The **USB** port on this stereo device is designed for playing media from USB memory devices.

### **Integrated Microphone**

For voice reception when making a call using the hands-free system.

### **Auxiliary Input Connector**

3.5mm auxiliary input stereo is designed for devices with line output 3.5 mm or hearing aids.

### **Reset System**

The **RESET** button is used to reset all factory settings parameters, this function can be used when the LCD screen does not work properly or if the sound is distorted, or when some of the controls are disable. Press the **RELEASE** button to release the front panel and remove it, use a thin object with a small tip to press the **RESET** button

## **RADIO OPERATION**

### **Change Bands (BAND)**

Press the BAND button to switch between the FM1, FM2, FM3, AM1 and AM2 bands. Each band stores up to six preset stations.

### **Manual Tuning (◀◀ / ▶▶)**

Press and hold the ◀◀ or ▶▶ button on the front panel or on the remote control to enter manual tuning mode. In manual tuning mode, press the ◀◀ or ▶▶ button to move the radio frequency number up or down one step.

### **Auto Seek Tuning (◀◀ / ▶▶)**

In standby mode or while not in manual tuning mode, quickly press the ◀◀ or ▶▶ button to move to the next/previous available station automatically.

### **To Store/Recall Preset Stations**

The radio can store 6 pre-set stations for each band (FM1, FM2 and FM3) for a total of 18 preset stations.

### **Memorize a station:**

- Turn the radio on and select the desired band and station.
- Select a station by ◀◀ or ▶▶ button.

- Press and hold the desired preset button (numbered 1-6 on the face of the radio) for more than 2 seconds to save the station to that preset number.

### To recall a preset station

- Select the desired band.
- Briefly press a preset button (numbered 1-6) to recall the corresponding preset station.

### Automatic Store station/ Preset station scan (AMS)

Press and hold the **AMS** button for more than 2 seconds to select six strong stations and store them in the current band. The radio will automatically scan the current frequency and enter the six strongest stations into the preset memory positions for that band. Briefly press the **AMS** button on the remote control to recall each preset station that saved in the memories in each band.

### LOCAL/DX

In urban areas, most stations are strong enough and “**LOCAL ON**” mode should be selected. Switch to **LOCAL OFF** mode to search for stations with weaker signals. Press the **LOC** button on the remote control to choose local or distant reception mode.

### STEREO/MONO

FM station is received in stereo mode. However, if the signal is weak or reception is not as good as you would like, switching to **MONO** mode usually improves the overall sound quality. Press the **ST** button on the remote control to choose **FM STEREO** or **MONO** audio effect.

## USB / SD CARD OPERATION

### Insert USB/SD CARD card

To play files from a USB/SD device, open the USB/SD port cover and insert the USB/SD device into the port, the songs will begin to play automatically.

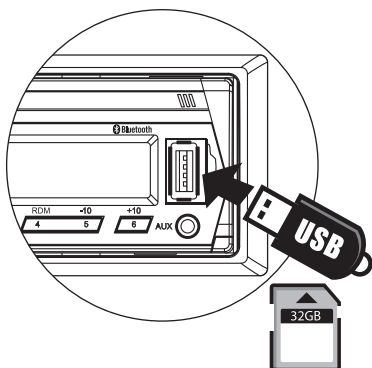

## **EJECT/USB/SD**

- To eject a USB device, press the ►|| button to stop playback, then remove the USB device.
- To eject an SD card, press the ►|| button to stop playback, and press the button to release and remove the front panel, then remove the SD card from the chassis.

## **Play/Pause**

Press the ►|| (play/pause) button to pause or resume playback

## **Next/Previous Track**

- To play the next track, press the ►► button.
- To play the previous track, press the ◀◀ button.

## **Fast Forward/Backward**

- To fast forward, press and hold the ►► button.
- To fast backward, press and hold the ◀◀ button.

## **Introduction Scan**

Press the INT button to play the first 10 seconds of each track, press again to stop the introduction scan, and play the current track.

## **Repeating the same track**

Press the RPT button to repeat the current track, press again to stop repeat playback and resume normal playback.

## **Playing all tracks in random**

Press the RDM button to play all tracks in random order, press again to cancel this function.

## **Track/Folder Navigation**

- During a disc, USB or SD card mode, press the **5/-10** button to go backward 10 tracks. Press the **6/+10** button to jump forward 10 tracks.
- During a MP3 disc, USB or SD card mode, press and hold the 5/-10 button to go back the previous folder. Press and hold the 6/+10 button to go to the next folder. You can repeat this function depending on the number and level of folders.
- These buttons have no this function if the USB device or SD card has no folders.

## **Select the track or file to play in MP3 format**

- a. Press and hold the AMS button to direct select a music file. The "TRK0000" will appear on the display.
- b. Turn the volume control to select the "first number". Then press the ◀◀ button to move the "first number" to the left and enter the next number.
- c. When the desired track number appears, confirm your selection by pressing SEL button.



## AUXILIARY INPUT OPERATION

This receiver is equipped with an external auxiliary input jack (3.5mm) on the front panel which is compatible with audio output from an MP3 music player.

Plug such a player into the AUX IN jack with a 3.5mm stereo audio cable and press the MODE button to switch to AUX input mode. "AUX IN" appears in the display. Listen to music from an external device through the speaker.

**Note:** Adjust the volume of the external device to a comfortable level with the receiver volume control.



## WIRELESS BT STREAMING OPERATION

### Pair and Connect

Prior to using the Wireless BT device as a hands-free system for a Wireless BT-enabled mobile phone for the first time, you must pair and connect the two devices as follows:

1. In any mode, prior to pairing and connecting, the BT logo in the LCD indicating that no device is connected. To begin pairing, enable BT mode on your mobile phone.
2. When the phone finds this ship/car audio system, the "PYLE" name will be displayed.
3. Choose the "PYLE" from the device list to pair and connect with this ship/car audio system. Upon confirming, the BT logo will stop flashing.
4. When pairing is complete, the mobile phone audio will automatically transfer to the ship/car audio system whenever a call is made or received, or when the mobile phone plays music.

### Make a Call

- To make a call, dial the call directly from the paired mobile phone.
- To make a call with this **Wireless BT** hands free system:
  - a. When linking up the **Wireless BT**-enabled mobile phone to this BT hands-free system, press the  button to access the dial telephone number mode, then press the "0~9", \* and # button on remote control to input the telephone number, and the entered number will be shown on the LCD display.
  - b. If a number has been incorrectly inputted, press the  button to delete it.
  - c. Press the  button to make outgoing call.

### Redial Last Dialed Number

- Press and hold the  button on the control panel to redial the last dialed phone number

## Answer a Call

- When the mobile phone is called, the incoming telephone number displays on the LCD.
- To receive the call, press the  button on the control panel.

## Reject a Call or End a Call

To reject or end the call, press the  button on the control panel.





## Switch Audio Between Car Audio and Mobile Phone

During a call, press the **VOL knob** button to switch the audio source from the car audio system back to your mobile phone.

## Adjust Talk Volume







- During a call, use **VOL knob** or **VOL+ ▲ /VOL- ▼** button to adjust the volume level.
- Use the **MUTE** button to mute sound.

## Audio Streaming (A2DP)

1. Press the /MODE button to enter BT mode and display pause in the LCD display.
2. When a mobile device is paired, music played through that device will automatically be heard through the car audio system.
3. Press the  or  button to play the next or previous on the mobile phone.
4. Press the  button to pause or resume music playback.

## REMOTE CONTROL

### Name of buttons and location

1.  (Power ON/OFF) Button switched on
2. **VOL +/VOL-** (volume up/down)
3. **Band** button,  (reply call)
4. Button  Tune down, seek down; Track down, fast reverse
5. **SEL** (selection) button
6.  **button**: Tune up, seek up; Track up, fast forward
7. **Mute** button, **DEL** (Delete) button
8. **CLK** (clock setting)  button, (end call) button
9.  button, preset station 1 button, keypad 1
10. **INT** (intro) button, preset station 2 button, keypad 2
11. **RPT** (repeat) button, preset station 3 button, keypad 3

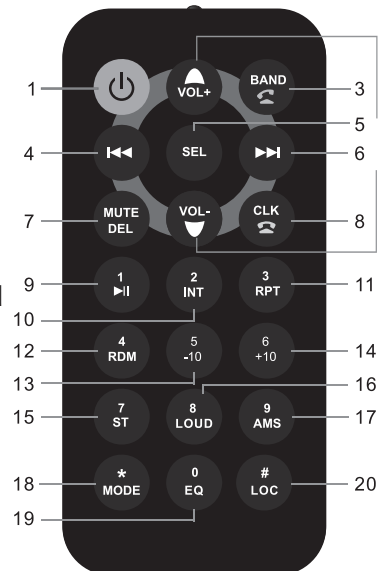

12. **RDM** (random), preset station **4** button, keypad **4**
13. **-10** (previous 10 tracks), preset station **5** button, keypad **5**
14. **+10** (next 10 tracks), preset station **6** button, keypad **6**
15. **ST** (stereo) button, keypad **7**
16. **LOUD** (loudness) button, keypad **8**
17. **AMS** (automatic music search) button, keypad **9**
18. **MODE** button, keypad **\***
19. **EQ** (Equalizer) button, keypad **0**
20. **LOC** (local)/**DX** button, keypad **#**

### Remove Insulating Sheet

The remote control comes with an insulating sheet attached to the underside of the remote control, as illustrated on the right. The remote control will not work until the insulating sheet is removed.

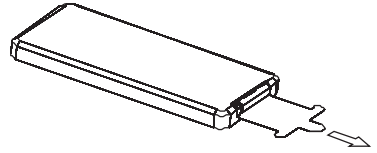

### Replace Lithium Battery Cell

1. When the lithium cell battery becomes weak, replace it as illustrated on the right.
2. Press and hold the movable block in the direction indicated by arrow 1. At the same time, pull the cell holder out of the remote control in the direction indicated by arrow 2.
3. Replace the old cell with a new one, making sure the (+) polarity is facing upward.
4. Re-insert the cell holder into the remote control

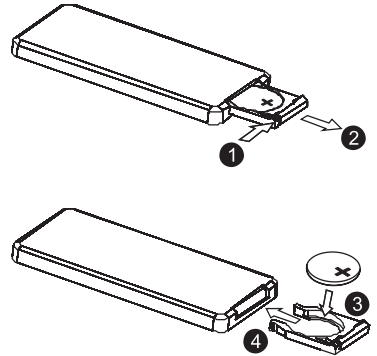

### Remote Control Operation

**Position the emitting window of the remote control toward the sensor window of the unit.**



- The operation angle for front panel remote control reception is about 30 degrees.
- The distance between the emitting window of the remote control and the sensor window of the unit should remain less 5 meters.
- Cell leakage may cause damage to the remote control.
- Do not throw cells into as this may cause an explosion.
- Keep battery cells out of reach of children.

## **TROUBLESHOOTING**

If you suspect something is wrong, immediately switch power off. Do not use the unit in abnormal condition, for example without sound, or with smoke or foul smell, can cause fire or electric shock. Immediately stop using it and call the store where you purchased it. Never try to repair the unit by yourself because it is dangerous to do so.

### **General**

**1. Vehicle's engine switch is not on.**

- Turn your Vehicle's key to ACC or ON.

**2. Cable is not correctly connected.**

- Check the connection.

**3. Fuse is burnt.**

- Replace fuse.

**4. Volume is in mute or minimum.**

- Check volume or mute on/off, adjust volume to a desired level.

**5. Sound skips.**

- The installation angle is more than 30°. Adjust the installation angle less than 30°.

**6. The operation keys do not work.**

- The built-in micro-computer is not operating properly due to noise. Press the RESET button to restore the program to zero.

### **Radio**

**1. Much noise in broadcasts.**

- Station or signal is too weak. Select other stations of stronger signal level.

**2. The antenna cable is not connected.**

- Insert the antenna cable firmly into the antenna socket of this receiver.

**3. Preset station is reset.**

- Battery cable is not correctly connected. Connect the battery cable to the terminal that is always live.

## HANDS FREE PUSH-TO-TALK

### PUSH-TO-TALK

- Allows you to access **SIRI** or **GOOGLE** voice via Wireless BT.
- Your phone must support **SIRI** or **GOOGLE** voice. Once connected to BT, your phone will ask for access to your contact list.
- Now you are ready to use **PUSH-TO-TALK**. Press the **PUSH-TO-TALK** icon. You are ready to talk. Call "**(CONTACT NAME)**" The system will call without having to use your phone.

### NOTE:

Samsumg "**S**" Voice and other associated Apps are not compatible.

### **PYLE APP**

**PYLE Smart App** is the ultimate in remote technology for your **PLMRB38B**, **PLMRB39W**, **PLMRK47BK**, and **PLMRKT49WT**. Download the **PYLE Smart app** from Google or Apple Store and install it on your phone or tablet.

Scan the QR code to download the PYLE Android App.



Scan the QR code to download the PYLE IOS App.



***PLMRB38B - PLMRB39W - PLMRK47BK - PLMRKT49WT***

**Marine Stereo Receiver Power Amplifier**

AM/FM/MP3/USB/AUX/SD Card Reader Marine

Stereo Receiver, Single DIN, 30 Preset Memory Stations,

LCD Display with Remote Control

**Features:**

- AM/FM/MP3/USB/AUX/SD Card Reader Marine Stereo Receiver
- Single DIN
- LCD Display with Remote Control
- Marine Stereo Receiver System
- AM/FM Stereo Radio, 30 Station Memory
- Wireless BT Streaming Audio Ability
- USB Flash & SD Memory Card Readers
- Aux (3.5mm) Input Connector Jack
- Connect & Stream Audio from External Devices
- MP3 Digital Audio File Playback
- LCD Display Panel
- USB/SD Card Reader
- Electronic Volume Control (10EQ, Balance, Fader)
- Memory/Repeat/Random/Intro Play
- Mute/Clock Control
- ID3 Tag Song Readout for Artist Name/Song Title
- RGB Button Control
- 1 pair RCA Output + 2x Subwoofer
- Equalizer (EQ) Electronic Audio Configuration
- Automatic Memory Preset Store/Scan Mode
- Repeat/Shuffle Song Functions
- Compatible With XBass, Siri Dialing, Android App, IOS App & Demo Mode

## Wireless BT Connectivity:

- Built-in Wireless BT Music Streaming
- Built-in Microphone for Hands-Free Calling
- Conveniently Reject/Answer Incoming Calls
- Compatible with All of Your Favorite Bluetooth Devices (iPhone, Androids, Smartphones, iPad, Tablets, etc.)
- Wireless BT Version: BT VERSION 4.2

## What's in the Box:

- Stereo Receiver
- Remote Control

## Technical Specs:

- Remote Control Battery Operated, Requires (1) Coin-Type Battery
- Battery Type: 3V Lithium Bat. 240mAh Capacity
- Single DIN Universal Size Standard
- Night illumination: RGB
- MAX. Power: 4x25W
- PLL Electronic Tuning Radio Tuner
- ISO with 4 Pin/8 Pin Wire Connector
- Stereo/Mono Mode Selectable
- Audio Control: 10EQ/Fader/Balance, No Treble & Bass
- Preset EQ: Flat/Pop/Rock/Class/Off
- Switchable USA/Europe Tuner Frequencies by Software
- Max. USB/SD Memory Support: 64GB
- Power: DC 12V
- Current Consumption: 10A
- Product Dimension: 4.5" x 7.1" x 1.97" - inches

### Questions? Issues?

We are here to help!

Phone: (1) 718-535-1800

Email: [support@pyleusa.com](mailto:support@pyleusa.com)



**WARNING:**

This product can expose you to a chemical or group of chemicals, which may include "**Nickel Carbonate**" which is known in the state of California to cause cancer, birth defects, or other reproductive harm. For more info, go to <https://www.p65warnings.ca.gov/>.

# PYLE

PyleUSA.com



**VISIT US ONLINE:**

*Have a question?*

*Need service or repair?*

*Want to leave a comment?*

[PyleUSA.com/ContactUs](http://PyleUSA.com/ContactUs)

PYLE