

PLRGSW104WT - PLRGSW104BK 10" Slim Waterproof Subwoofer

400 Watts at Dual 4-Ohms Car Audio Powered Subwoofer with Multi-Color RGB Lights and Remote Control, PP Cone with Rubber Edge

PYLE
PyleUSA.com

USER GUIDE

Features:

- 10" Slim Waterproof Subwoofer
- Completely Waterproof
- For Marine or Car Use
- Multi-Color RGB Lights and Remote Control
- PP Cone with Rubber Edge
- High-Powered Car Subwoofer
- Lab Tested Pro Audio Woofer Performance
- Massive Butyl Rubber Surround
- High Strength Engineering Plastic Basket
- Quick Connect Speaker Terminal
- Compatible with Sealed Enclosure Speaker Box Audio Setup
- Impressive Bass Response, Low-Resonance Frequency Output
- Designed for Custom Audio Car, Truck, Mobile Vehicle Applications

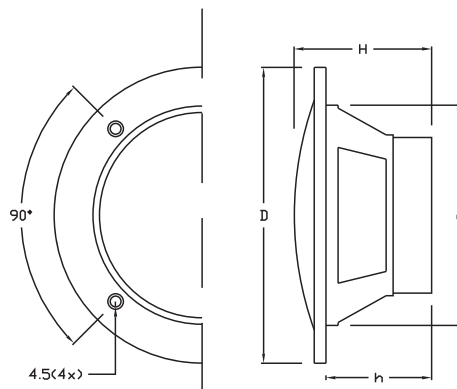

Connection Diagram

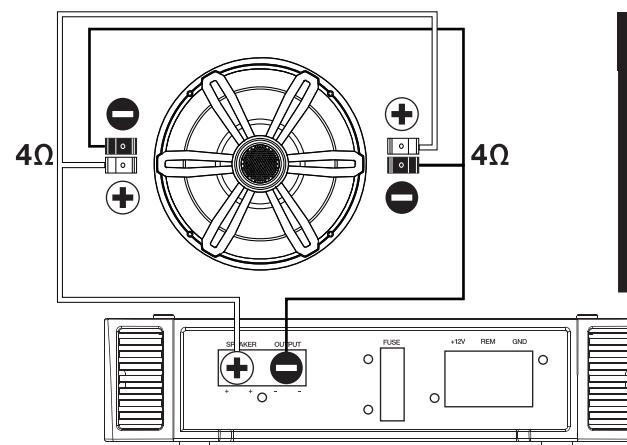

ATTENTION:

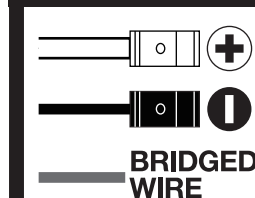

Installation Guide

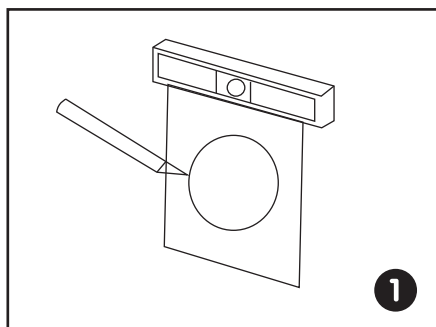

Cut the drywall.

Note: Always allow at least one-half inch between a wall stud and the speaker cutout or the locking tabs will not be able to swivel into place.

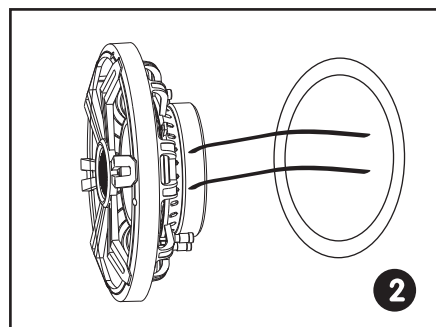

Connect the speaker wires to the speaker.

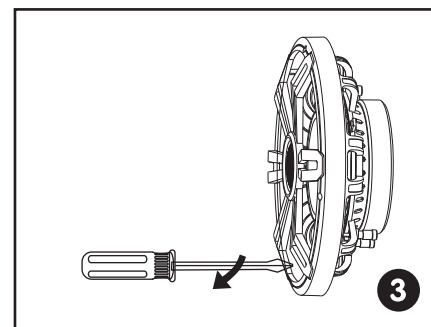

Screw down each of the four Phillips head screws. The locking tabs will swivel into place and secure the unit to the rear surface of the drywall. Put in the strips of adhesive to secure the grille.

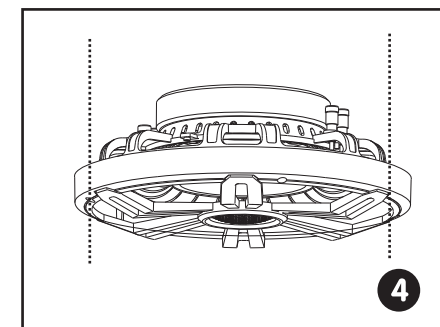

Replace the metal grille.

Remote Control

- 1. Turn On/Standby:** Press this key to turn **ON** unit or switch to stand by mode. At power on, unit will automatically turn ON and restore to previous status.
- 2/9. Dynamic Mode Adjust:** Switch to dynamic mode from static color or switch between dynamic modes.
- 3/10. Dynamic Speed Adjust:** Adjust dynamic playing speed. Press **SPEED+** to increase speed and press **SPEED-** to decrease. Unit will switch to dynamic mode if pressing this key at static color mode.
- 4/5. Static Color Adjust:** Switch to static color mode from dynamic mode, or switch between static colors.
- 6. Direct Color Select:** Shortcut key to static colors. When pressing the specific color key, LED will play the same static color. The direct colors are included in 'COLOR+' and 'COLOR-' operation.
- 7/8. Brightness Adjust:** Adjust static color brightness. Press **BRIGHT+** to increase brightness and press **BRIGHT-** to decrease. Unit will switch to static color mode if this key is pressed at dynamic mode.
- 11. Demo Mode:** Press this key to switch to Demo mode. At demo mode, it plays 17 dynamic modes in loop, each mode repeat 3 times.

What's in the Box:

- 10" Slim Waterproof Subwoofer; RGB wire; remote control

Technical Specs:

- Construction Materials: Engineered ABS
- Power Handling: 400W Max, 200W RMS
- Impedance: Dual 4 Ohms
- Voice Coil: 2.0" -in
- Voice Coil Type: High-Temp Aluminum
- Magnet Size: 40 Oz
- Magnet Type: Barium Ferrite Magnet
- Frequency Response: 30Hz - 200Hz
- Sensitivity: 92 dB
- Remote Control Battery Operated, Requires (1) x'CR2025' Batteries
- Battery Type: 3V Lithium Battery
- Battery Life: Up to 2+ Hours
- Product Dimensions: 10.5" x 9.3" x 3.1" -inches

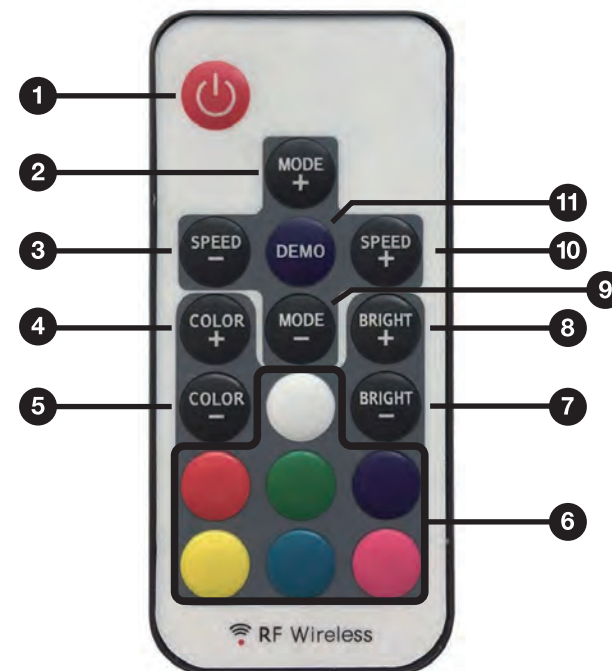

Questions? Issues?
We are here to help!
Phone: (1) 718-535-1800
Email: support@pyleusa.com