

PYLE

PyleUSA.com



VISIT US ONLINE:
Have a question?
Need service or repair?
Want to leave a comment?
PyleUSA.com/ContactUs

PYLE

Questions? Issues?

We are here to help!

Phone: (1) 718-535-1800

Email: support@pyleusa.com

PowerSports

PYLE
PyleUSA.com



PLUTV58BKA

5.25" Waterproof Marine Speakers

+ 2 Ch. Rated Amplifier + Wireless BT Audio Controller
ATV, UTV, 4x4, Jeep, Wired RCA, for Boat Stereo Speaker
and Other Watercraft (1000W)

USER GUIDE

PRECAUTIONS

- This unit is designed for negative ground 12-14.50 Volts (DC) operation only.
- Use speakers with an impedance of 4 Ohms
- **Avoid installing the unit where:**
 - It would be subject to high temperatures, such as from direct sunlight or hot air from the heater.
 - It would be exposed to rain or moisture.
 - It would be subject to dust or dirt.
- If your vehicle or boat is parked in direct sunlight and there is a considerable rise in temperature inside the car, allow the unit to cool off before operation.
- When installing the unit horizontally, be sure not to cover the heatsink fins with the floor carpet.
- If this unit is placed too close to the resources radio, an interference may occur. In this case, separate the amplifier from the car radio.
- This power amplifier employs a protection circuit to protect the transistors and speakers if the amplifier malfunctions. Do not attempt to test the protection circuits by covering the heatsink or connecting improper loads.
- Do not use the unit with a weak auto battery as its optimum performance depends on a normal battery supply voltage.
- For safety reasons, keep the volume of your audio system moderate so that you can still hear normal traffic sounds in a reasonable distance.

WIRING INSTRUCTIONS

POWER CONNECTION

The battery terminal (BATT) must be connected directly to the positive terminal of the vehicle battery to provide an adequate voltage source and minimize noise. Connecting the battery terminal lead to any other point (such as the fuse block) will reduce the power output and may cause noise and distortion. Use only #12 gauge or thicker (smaller gauge #) wire for this lead and connect it to the terminal of the battery after all other wiring is completed.

GROUND CONNECTION

The ground terminal (GND) connection is also critical to the correct operation of the amplifier. Use a wire of the same gauge as the power connection (#8 or thicker) and connect it between the ground terminal (GND) of the amplifier and a metal part of the vehicle close to the mounting location. This wire should be as short as possible and any paint or rust at the grounding point should be scraped away to provide a clean metal surface to which the end of the ground wire can be screwed or bolted.

REMOTE TURN-ON CONNECTION

The amplifier is turned on by applying +12V to the remote turn-on terminal (REM). The wire lead to this terminal should be connected to the "Auto-Antenna" lead from the vehicle/or boat stereo resources which will provide the +12V only when the stereo resources is turned on. If the car stereo does not provide an "Auto-Antenna" lead, the remote turn-on lead may be wired to an "Accessory" or "Radio" terminal in the vehicle's/or boat's fuse block. This will turn the amplifier on and off with the ignition key, regardless of whether the stereo resources is on or off. The remote turn-on lead does not carry large currents. So #16 gauge wire may be used for this application.

SPEAKER CONNECTIONS

Depending on the type and number of speakers used with the amplifier wire them to the speaker terminals as per the appropriate wiring diagram. For most applications #18 gauge wire should be used for the speaker leads but in no case thinner than #16 gauge. For leads in excess of 10 feet #12 gauge is recommended. When wiring the speakers, pay careful attention to the polarity of the terminals on the speakers and make certain they correspond to the polarity of the corresponding terminals on the amplifier. Do not ground any speaker leads to the chassis of the vehicle/or boat.

OPERATION

After the amplifier has been installed and all connections have been made carefully and securely, turn the radio on so that the amplifier is switched on automatically. After a short power-on period, the amplifier reaches its full performance. Now turn up the volume slowly using the volume control of the radio. If there is no sound or only a distorted replay, switch off the radio immediately - the amplifier will also switch off automatically - and check if all connections have been made correctly.

GND (-) = GROUND CONNECTION

Connect the GND terminal to the chassis ground of your vehicle/or boat and take care of best electric and mechanic contact. In doing so, drill a hole into the vehicle/or boat chassis near the amplifier then remove color, dirt or any other substance from the ground point. Thereafter fasten the cable end with added ring terminal by using a screw. Ensure that the ground connection is as short as possible and that the cable diameter is sufficient (min 4mm). Route the ground cables from the radio and all other equipment parts, like equalizer, active crossover network or other amplifiers, to the same ground point.

+ 12V = POWER SUPPLY

Connect the BATT terminal to the positive pole of the battery with a lead cable and add a fuse into the power cable in a distance of not more than 30 cm from the battery. The lead cable's diameter should be at least 4 mm' for a length of 3 m and 6 mm" for a length of 6 m.

REM (ON/OFF) REMOTE CONTROL

Connect the REM terminal to the automatic antenna connector of your vehicle/or boat radio. Now when turning on and off your vehicle/or boat radio, the amplifier automatically switches ON and OFF. A cable diameter of 0.5mm² is sufficient.

SPEAKERS CONNECTIONS

Speaker Output

L-OUTPUT+	White
L-OUTPUT-	White+Black
R-OUTPUT+	Grey
R-OUTPUT-	Grey+Black

Line Output

OUT	White (L)
OUT	Red (R)

AUX Input

AUX Input	Black
-----------	-------

Power

+ 12V	Red
GND	Black
REM	Blue

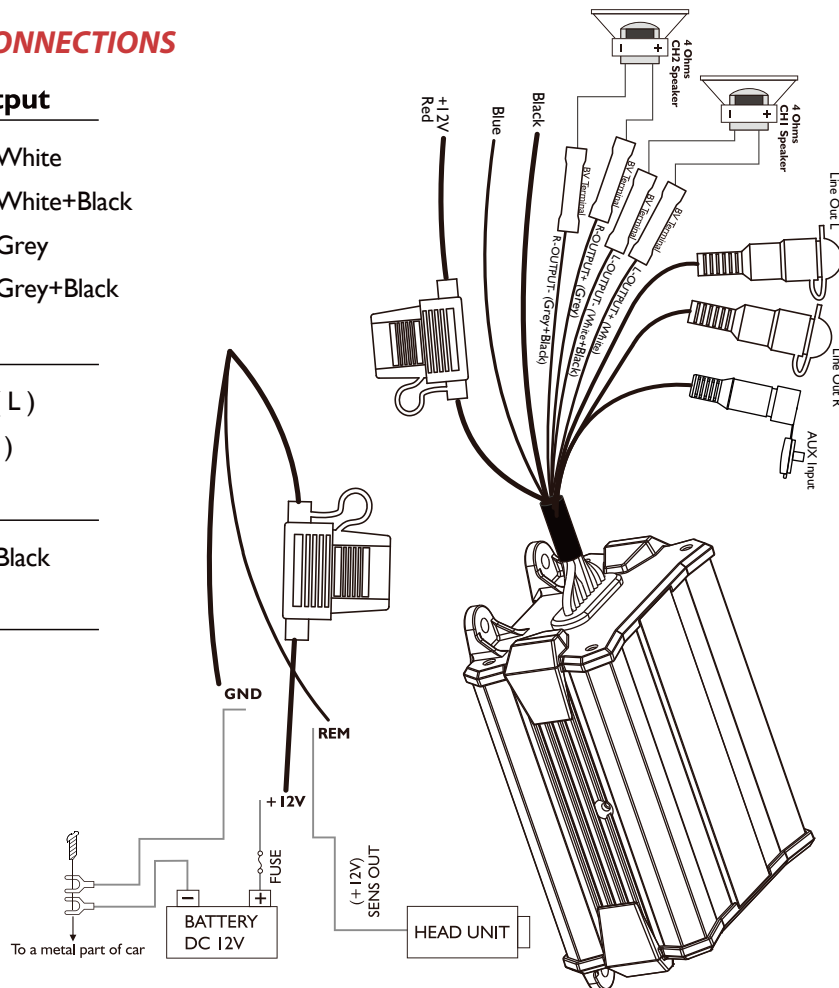

POWER CONNECTION LEADS

NOTES ON THE POWER SUPPLY

- Connect the +12V power input lead only after all other leads have been connected.
- Be sure to connect the ground wire of the unit securely to a metal part of the vehicle/or boat.
- Loose or faulty connection may cause amplifier malfunction
- **REM:** The unit is turned on by applying +12 Volts to this terminal. This terminal does not draw heavy current like the tow Power Terminals so a thinner connecting wire is acceptable. Standard 18 GAUGE is fine and the standard color is red. If the radio is equipped with a Power Antenna control wire, it can drive this terminal. If the Power Antenna wire is already in use, you can still splice into it. With this method, the unit will turn ON automatically with the radio.
- Use the power supply lead with a fuse attached whose value is the same as original fuse.
- Place the fuse in the power supply lead as close as possible to the car battery.
- During a full power operation, Maximum current will run through the system. Therefore, make sure that the leads to be connected to the +12V and GND terminals of the unit respectively must be larger than 18-Gauge (AWG.18) proper Bridged operation. If only mono signal is available, a "Y" adapter is required.

FUSE REPLACEMENT

If the fuse blows, check the power connection and replace the fuse. If the fuse blows again after replacement, there may be an internal malfunction. In this case, consult your dealer.

WARNING

Use the specified amperage fuse. Use of a higher amperage fuse may cause serious damage.

PROTECTION CIRCUIT

This amplifier is provided with a protection circuit which operates in the following cases when:

- the unit is overheated.
- the speaker terminals are short circuited.

HOW TO PROCEED IN CASE OF FAULTS

No Function:

- The connection cable is not connected correctly (=terminal +12V/GND/REM). Ensure that all connections and mechanic contact and that the jacket has been removed. The fuse is defective-pay attention to the correct value of a new fuse!

No Sound:

- Speaker cable or speaker plug are not connected correctly.
- The plus and minus wires of the speaker cable have contact, thus eliminate the short circuit. If you use Pay attention only 4 ohm load speaker is allowed. No 2 ohm or less impedance speaker connection is allowed.

Poor Sound Quality (Distortions):

The speakers are overloaded, therefore turn down the volume level and check the volume control positions.

No Stereo Sound And A Weak Bass:

Speaker cables (+) and (-) are mixed up, unit wired out of phase.

INTERFERENCE

All cables can source and create interference. The power cable and Cinch/RCA audio cable are very prone to interference; the remote cables are less prone. There is often interference caused by the generator (piping), ignition (cracking) or other vehicle/or boat electronic parts. Most of these problems can be eliminated by correct and careful cabling. In doing so, here are the following guidelines:

- Use only a screened audio cable for the wiring between "low level in" of the amplifier and RCA or DIN output of the radio.
- Lay the signal, speaker and power cables separately with enough distance from one another and also from each other car cable. If not possible, you can lay the circuit and ground cable together with the serial cables. Audio and speaker cable should be as far away from these as possible. The REM cable to the automatic antenna output of the radio can be laid together with the signal cables.
- Avoid ground loops by laying the ground wiring of all components to a center point in a star-like way. You can find the best central point in measuring the voltage directly at the battery. Now compare this voltage value with the chosen ground point and the (+) terminal of the amplifier. If measured voltage is only slightly different, you've found the correct central. Otherwise you have to look for another point. You should measure with the ignition point for earth being switched on and additionally switched on consumers (rear window heating and light).
- If there are pickups from external electrical sources into the speaker cables, divide the core leads and twist them together.
- If there are noises from the car electrics, add an interference suppression choke into the power wiring.
- If there are humming noises, use thicker ground cables or add further ground cables to the chassis.
- To reduce contact resistance and bad and loose contacts, please solder the cable ends or use multi core cable ends, spade terminals or others. Gold Plated spade terminal are free of corrosion and have the lowest contact resistance.
- Should all these measures be without any success, the use of a ground loop isolator may solve the problem.

PLUTV58BKA Speaker Installation

Speaker Mounting suggestion as below:

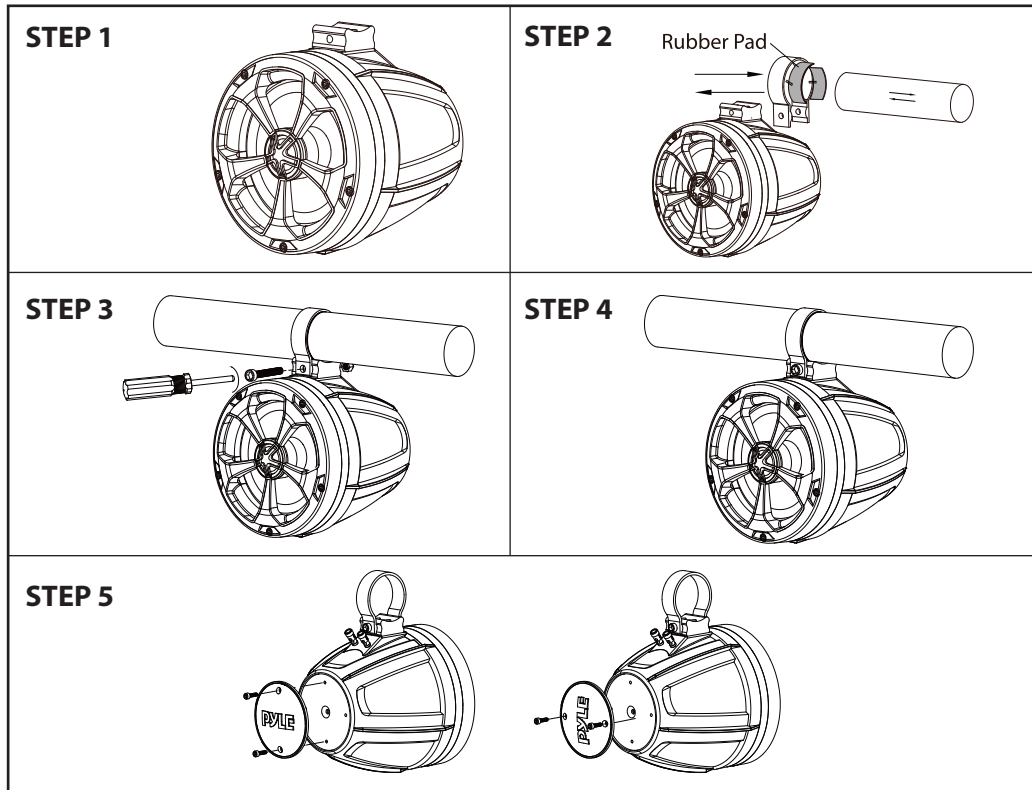

Auto Reconnection:

Step 1: Put the **PLUTV58BKA** speaker in a safe place.

Step 2: Slide in the buckle with rubber pad attached to the bracket stand of the speaker. Attach the set to the handle bar of vehicle/ship.

Step 3/4: Attach screw to lock the buckle.

Step 5: Option for adjustable PYLE logo---Unbolted the screws first, adjusting logo direction, then re-fix screws.

WIRE DIAGRAM

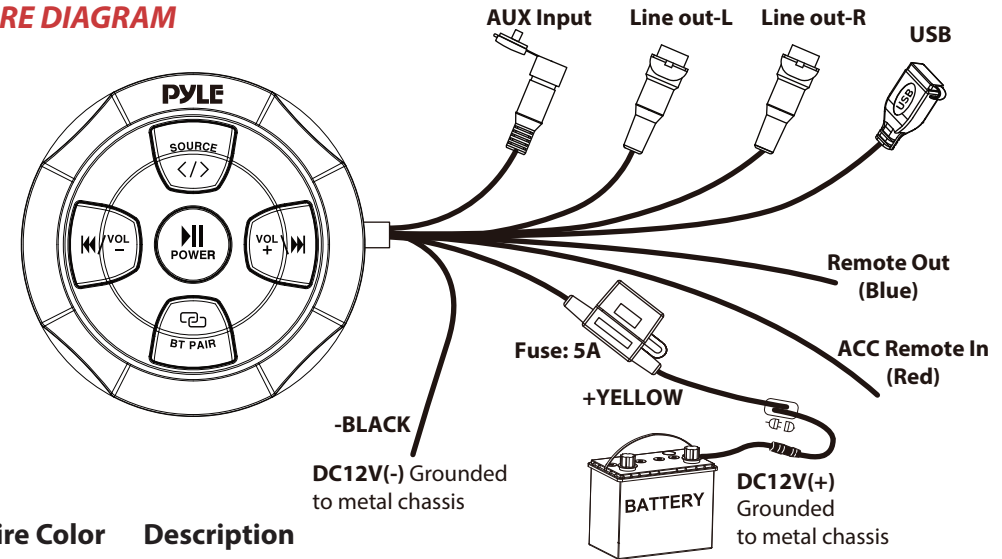

Wire Color	Description
Yellow	Battery (+), 12dc
Black	Battery (-), Ground
White	Line out - L
Red	Line out - R
Red	ACC
Blue	REMOTE

WIRELESS BT PAIRING AND CONNECTION

Power: Press and hold the power button to power ON/OFF.

Wireless BT Streaming Connection:

- Ensure BT ability is activated, then search for the **PLUTV58BKA** from your BT-enabled device. The light will turn blue and blinks while waiting for BT connection.
- The **PLUTV58BKA** BT Network Name will appear as "**PyleUSA**" (No password is required for connecting).
- When the BT is connected, the light will turn blue and stops blinking.









AUX-IN/USB: Short press ^{SOURCE} </> to switch BT mode to Aux-in mode/USB mode.

Auto Reconnection

- When the device is out of BT range, BT will be disconnected automatically, the light turns blue while blinking.
- BT will automatically reconnect when detected in range again in 10 minutes.

- c. Disconnected BT after 10 minutes, you need to process BT connection steps (above) to reconnect BT again.
- d. If the other device occupied the BT during this period (10mins), you need to process BT connection steps (above).

PLAYING MUSIC

1. Press and hold  for 3 seconds to Power ON or OFF.
2. Short press  to play music or pause.
3. Short press  to switch BT mode/Aux-in mode/USB mode.
4. Short press  for next track, Press and hold  for volume up.
5. Short press  for previous track, Press and hold  for volume down.
6. Press and hold  to disconnect BT.

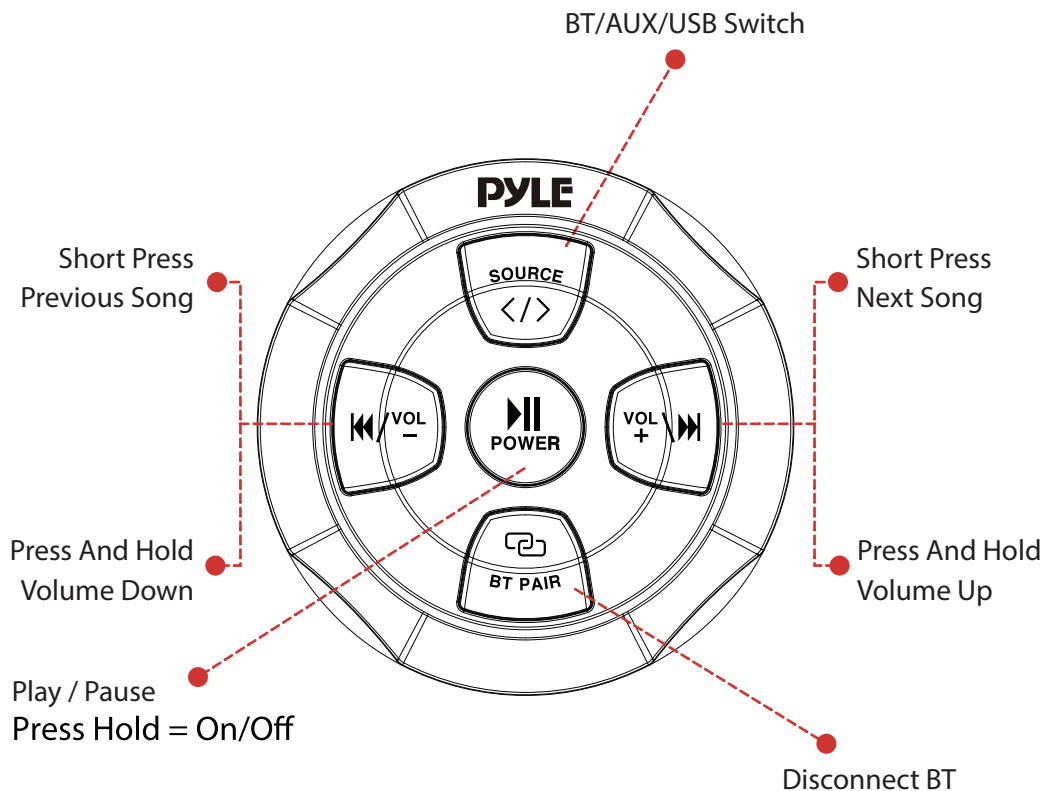

INSTALLATION (SEAMLESS FLUSH MOUNT)

Size:

- 96mm/3.7" (Overall Diameter)
- 70mm/2.76" (Overall Diameter)
- 76mm/3.0" (Mounting Hole Diameter)
- 52mm/2.05" (Mounting Depth)

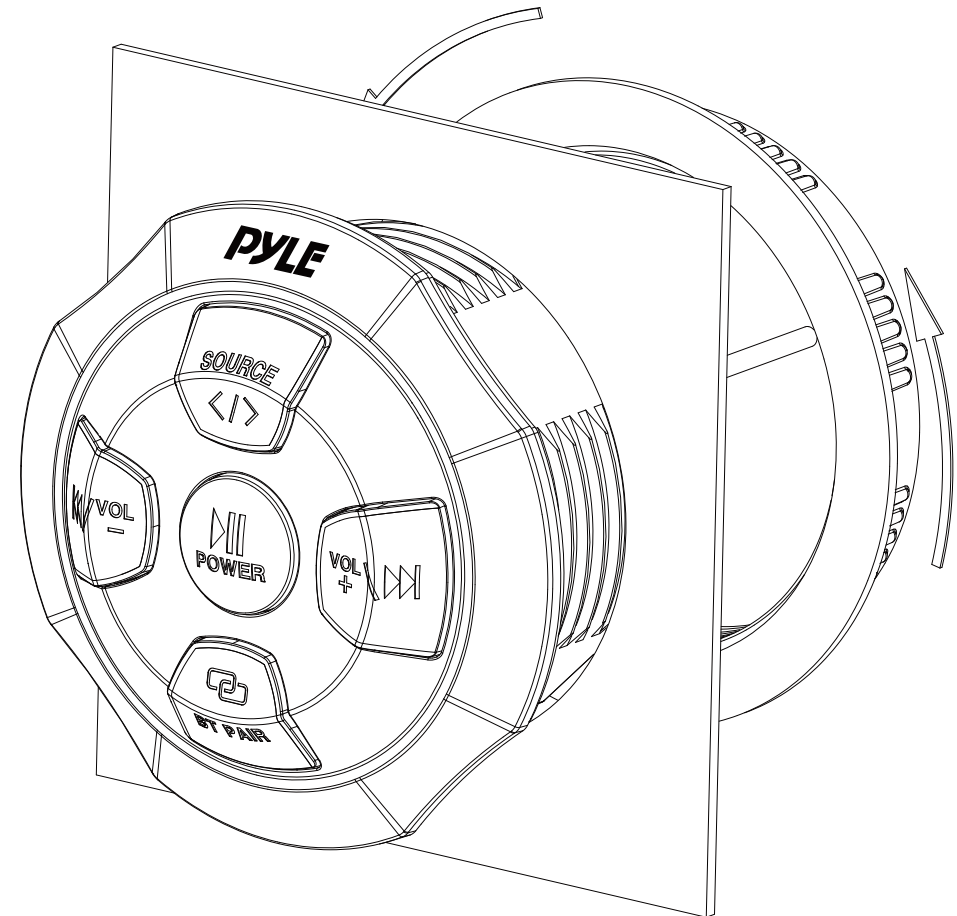

PLUTV58BKA WIRE DIAGRAM

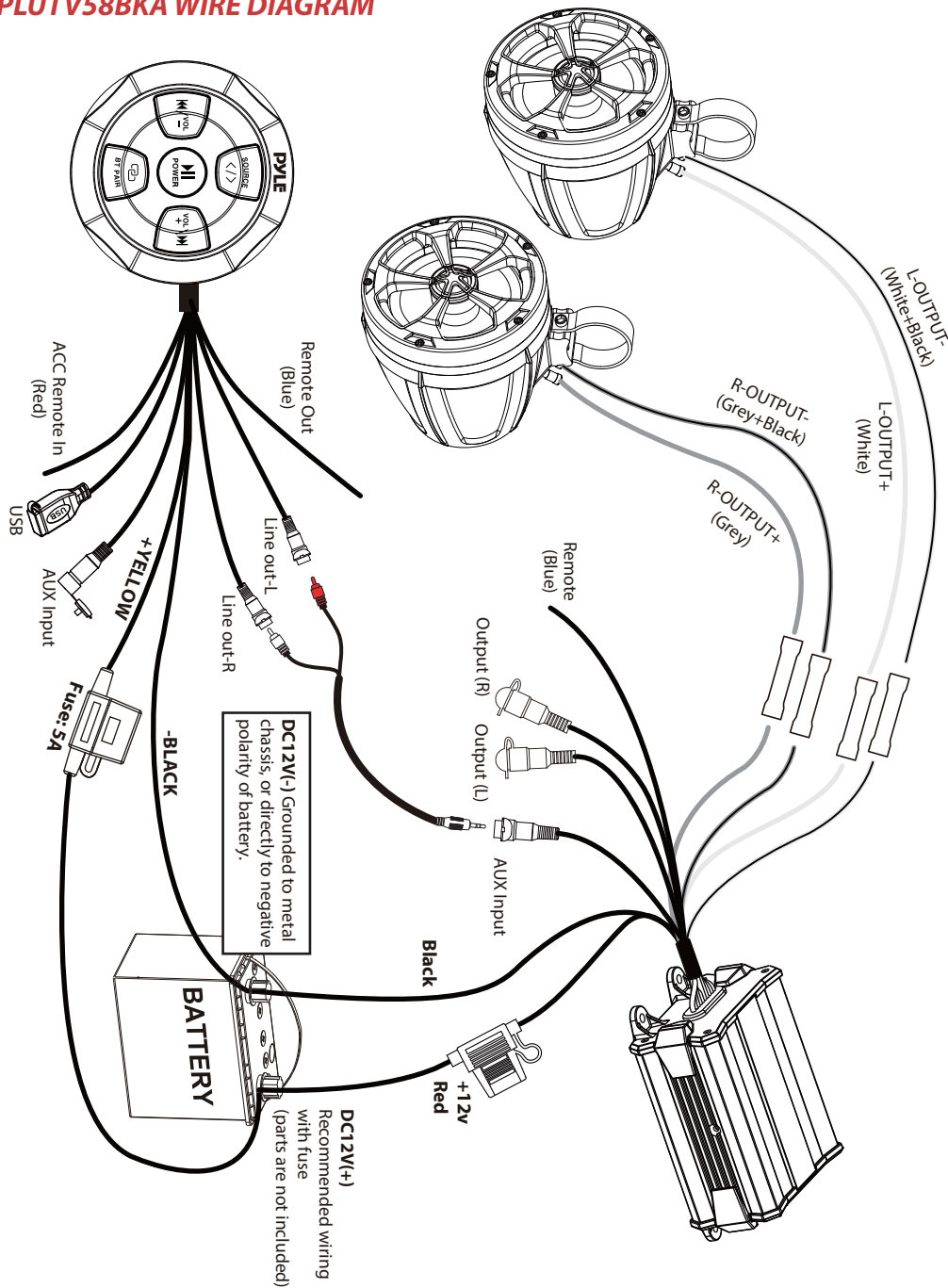

Features:

- Waterproof Rated Speakers
- Pro Audio Power Sports Amplifier System Kit
- 2-Channel Marine Audio Amplifier
- Marine Grade Rugged Construction
- Waterproof Rated & Weather-Resistant Connectors
- Integrated Power Wiring Harness
- Perfect for Custom Installations & Applications
- Ability to Connect & Stream Audio from External Devices
- Speaker Wiring Connectivity
- Aux (3.5mm) Input
- Full-Range Stereo Sound Reproduction
- Pre-Amp RCA Out to Any OEM/Factory-Made Mono-Block/Full-Range Amplifier
- USB Input to Play Your Favorite Music Files
- Flush Mount Mounting Kit Included
- Anti-Thump Turn-On
- Soft Turn On / Off
- Overload & Power Protection Circuitry
- Used for Watercraft & Portable Mobile Vehicle Sound Systems

What's in the Box:

- (1) Wireless BT Control Unit
- (1) 3.5 mm Auto Connection Cable
- (1) RCA to 3.5 mm Auto Connection Cable, 6.5' ft.
- (2) 5.25"-inch Marine Speakers
- (2) Speaker Connection Wires, 6.5' ft.
- (2) 1.75" Aluminum Mounting Brackets
- (2) 2" Aluminum Mounting Brackets
- (2) 6.5" x 0.95" x 0.67" Inches Rubber Pads
- (2) 5.7" x 0.95" x 0.67" Inches Rubber Pads
- (2) 6x50mm Hexagon Socket Head Cap Screws
- (2) Stainless Steel Nuts
- Compact 2 Channel Marine Amp
- (4) Butt Connector 16-22AWG
- Screw Bag
- (4) Nylon Wire Straps

Amplifier Technical Specs:

- Amplifier Type: 2-Ch. Audio Component
- Power Output: 1000 Watt MAX
- 2 x 50 Watts RMS @ 4 Ohm
- 2 x 150 Watts MAX @ 4 Ohm
- Marine Grade IP-45 Rating
- T.H.D.: ≤ 1%
- S/N Ratio: ≥ 80dB
- Channel Separation: ≥ 65dB
- Fuse: 15A
- Power: DC 12V
- Amp Dimensions (L x W x H): 6" x 3.86" x 2.36" –inches

BT Control Unit:

- Simple & Hassle-Free Pairing
- Instant Wireless Audio-Streaming Receiver
- Works with All of Today's Latest Devices
Smartphones, Tablets, Laptops, Computers, etc.
- Wireless BT Version: 5.0
- Wireless BT Network Name: 'PyleUSA'
- Wireless Range: Up to 30+ ft

Marine Speaker Technical Specs:

- Power Output: 1000 Watts
- Marine Grade Waterproof Rating: IP-X45
- Speaker Size: 5.25" -inch (Each)
- Speaker Style: Passive Speakers
- Speaker Type: Polypropylene Cone, Butyl Rubber Surround (x2)
- Tweeter Type: Neodymium Dome (x2)
- Impedance: 4 Ohm
- Magnet Type: 24 oz. Circuit
- Mid-Woofer Voice Coil Type: 1", Aluminum Sensitivity: 88 dB +/- 2 dB @ 1M/1W
- Universal Mounting Brackets Roll-Bar / Roll-Cage Diameter: 1.75" ~ 2.0" –inches
- Speaker Dimensions: 6.5" x 7.1" x 9.5" -inches, with Bracket (-Each)



California Prop 65 Warning

⚠️ WARNING:

This product contains Di (2-ethylhexyl) phthalate (DEHP) which is known to the state of California to cause cancer birth defects and other reproductive harm. Do not ingest.

For more info go to: www.P65warnings.ca.gov