

Model
PRJCM3



A1*4



A2*8



A3*4



A4*8

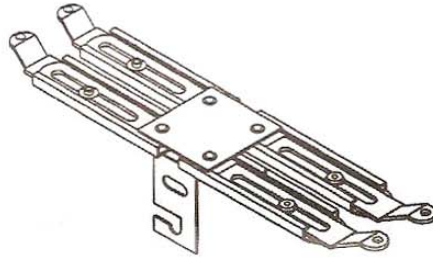

A5*1

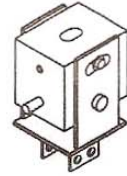

A6-1

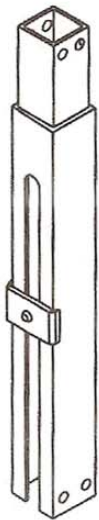

A7-1

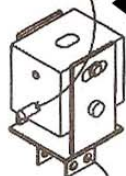
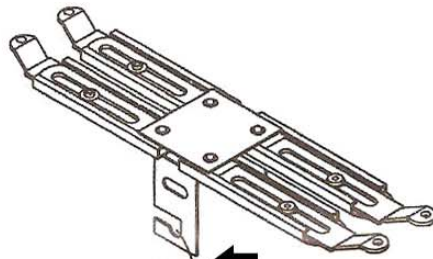

Align Holes
and
Tighten Screws

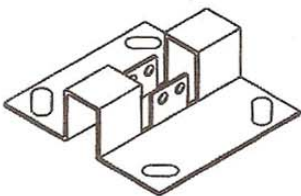
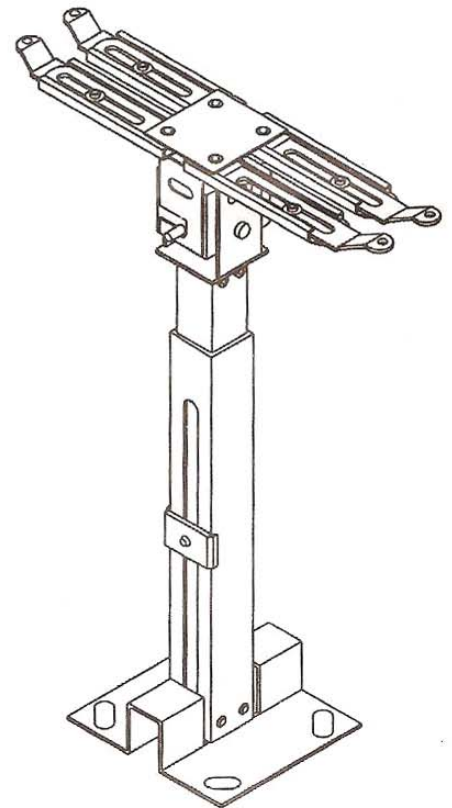
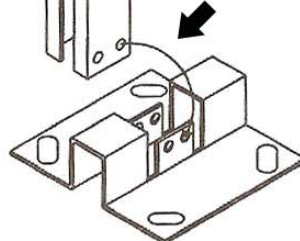
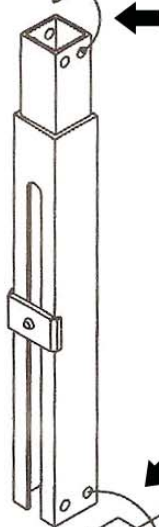

A8-1



Universal Projector Ceiling Mount Kit with Telescoping Height and Angle Adjustment

- Compatible with virtually any standard projectors
- Versatile mount extension and angle adjustment configurations
- Securely holds devices up to 17.63 lbs. (8.0Kg)
- Telescoping Height Adjustment: 11.81" - 25.60"
- Conceals and protects cables
- Perfect for the home or office
- Includes mounting hardware and accessories
- Size adjustable to ensure projector compatibility
- Designed not to interfere with ventilation or cooling fans
- Horizontal, vertical and height (angle and tilt) adjustments
- Durable and polished mounting assembly kit