

PYLE

PyleUSA.com





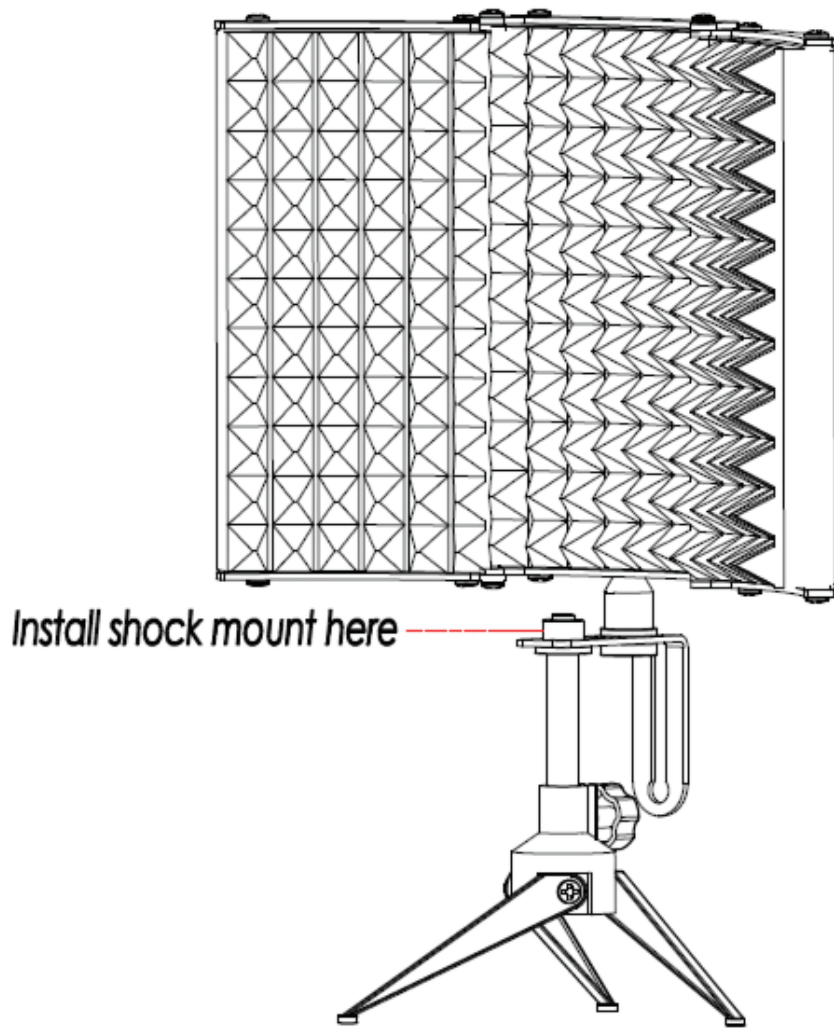

USER'S MANUAL

SOUND ISOLATION

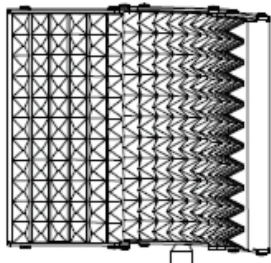
PSMRS08



A	 Adjustable Panel	1	C	 Steel Track Sheet	1
			D	 Steel knob with 3/8" thread male	1
			E	 Mini tripod (you can also use microphone stand)	1
B	 3/8" to 5/8" Adapter	3			

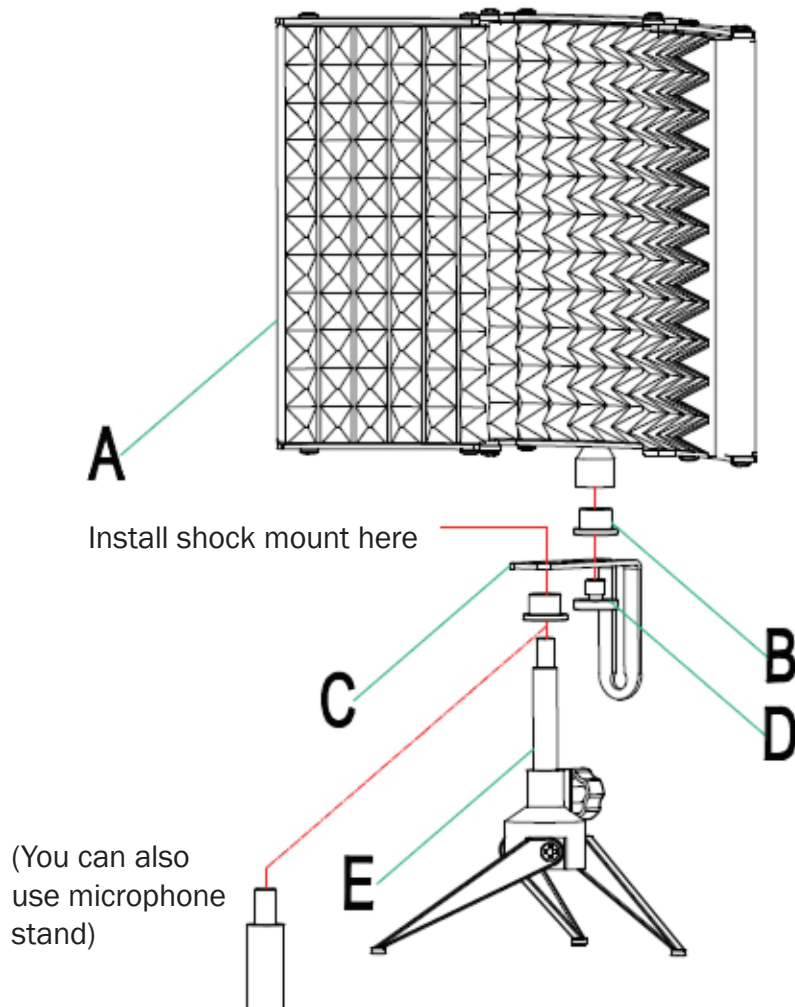

SOUND ISOLATION FEATURES AND SPECIFICATIONS

Features:

- Versatile Mic Recording & Sound Isolation Ability
- Portable and Compact Design
- Ready to Record: Quick & Easy Setup
- (3) Soundproofing Studio Foam 'Wedgie' Acoustic Tiles
- Angle & Depth Adjustable Absorption/Isolation Panels
- Height Adjustable: 13.2 - 15.6"
- High Density Noise-Absorbing Acoustic Foam
- Universal Standard 5/8" Microphone Threading
- Rugged & Heavy-Duty Shell Panel Construction
- Tri-Pod Base Design for Desktop/Tabletop Stability
- Perfect for Studio Recording, Podcasts, Vocals, Singing, etc.
- **Shock Mount & Microphone Not Included*
- Foam Color: Charcoal Gray
- Folds for Storage

Size / Dimensions:

- Assembled Dimensions (L x W x H): 13.2" x 7.2" x 15.6"
- Sound Absorption Panel Thickness: 2" -inch
- Weight: 2.35 lbs.

PYLE

PYLE

PyleUSA.com