



# serenelife™



## 54" Air Hockey Table

for Game Room, Home, Office, with 2 Pucks, 2 Pushers,  
Digital LED Score Board, Powerful 12V Motor



SCAN TO WATCH  
SETUP TUTORIAL VIDEO

**USER GUIDE**



## IMPORTANT

After receiving the shipment, inspect the product thoroughly to ensure that it has been shipped with care. Before assembly make sure that the packaging contains all parts.

### FEATURES:

- Compact Design
- Perfect for any Gameroom or Apartment
- Space Saving
- Stylish Design
- Scratch Resistant and Durable Surface
- Heavy Duty Plastic Corners
- Digital LED Score Board
- Safe and High-Quality Design
- Sturdy Construction
- Adjustable Foot Caps
- Crossbar Leg Supports with Protective Corners
- Built-in Score Tracker and Puck Dispenser
- 12V Fan Motor Pushes Air through the Surface for Smooth Gliding
- Adjustable Levelers and Crossbar Leg Support for Stability













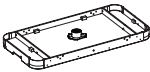



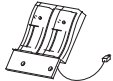

### WHAT'S IN THE BOX:

- 54" Air Hockey Table
- (4) Pusher
- (2) Puck





### TECHNICAL SPECS:

- Construction Material: MDF with PVC and Graphic
- Pusher: 3" -inches
- Green Pad: 2.9" -inches
- Puck: 2 -1/8" inches
- Hockey Table Thickness: 1/2" MDF -Inches
- Hockey Table Dimensions (L x W x H): 54" x 27" x 32-1/2" -Inches

## PARTS LIST

1  Mainframe x1	2  Right Leg x2	3  Left Leg x2	4  Leg End Panel x2
5  Leg Side Panel x2	6  Electronic Scorer x1	7  Round Puck x2	8  Pusher x4
9  Felt Pad x2	10  Goal Box x2	11  Adaptor x1	12  Leg Leveler x4
A1  Wrench x1	A2  Leg Bolt x28	A3  Leg Washer x28	A4  4 x 12mm Screw x4
A5  3.5 x 15mm Screw x2			











## PRE-INSTALLED PARTS

P1  Apron Corner x4	P2  1/4" T-Nut x28	P3  5/16" T-Nut x4	P4  Motor x1	P5  Connection box x1
---	--	--	--	---

## ASSEMBLY INSTRUCTIONS:

1. Find a clean, level place to begin the assembly of your Air Hockey Table. The table must be assembled upside down and then turned over on its legs once the assembly is completed. This game table is heavy, and turning it over will require at least two strong adults.

2. Remove all parts from the box and verify that you have all the listed parts as shown on the parts list page. Carefully cut or tear the four corners of the box so that the bottom of the box can be used as your work surface.



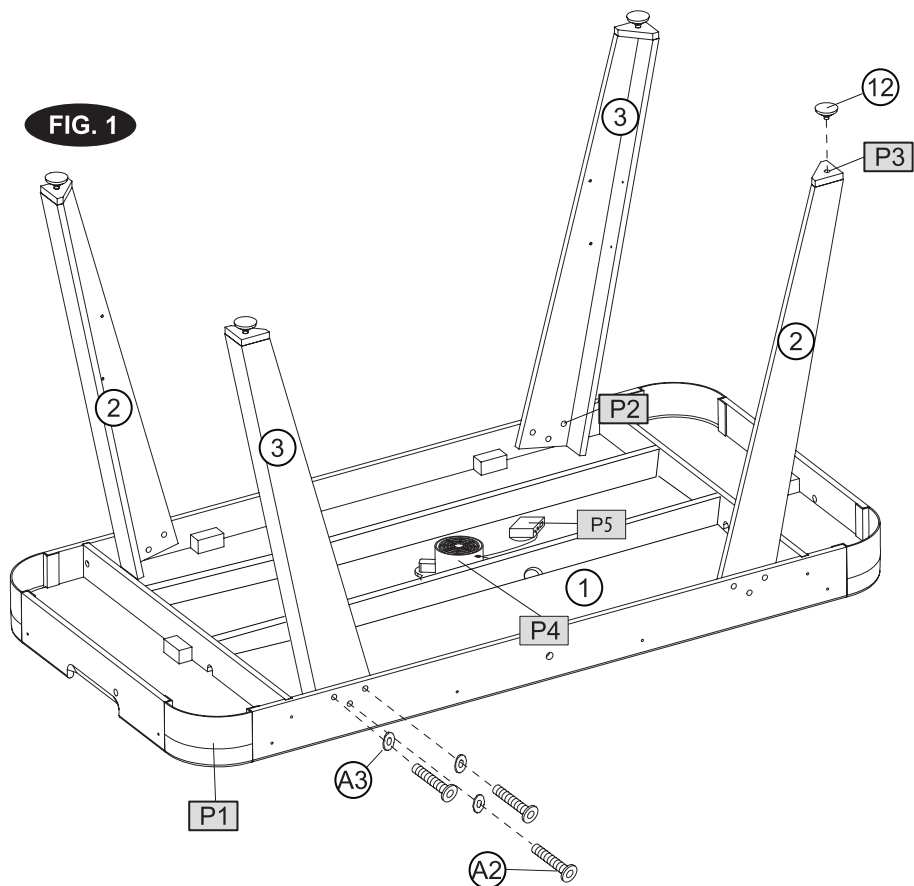

<b>1</b>  X1	<b>2</b>  X2	<b>3</b>  X2	<b>12</b>  X4	<b>A2</b>  X12	<b>A3</b>  X12	<b>P1</b>  X4	<b>P2</b>  X12	<b>P3</b>  X4	<b>P4</b>  X1	<b>P5</b>  X1
--	---	---	--	---	---	--	---	--	--	---

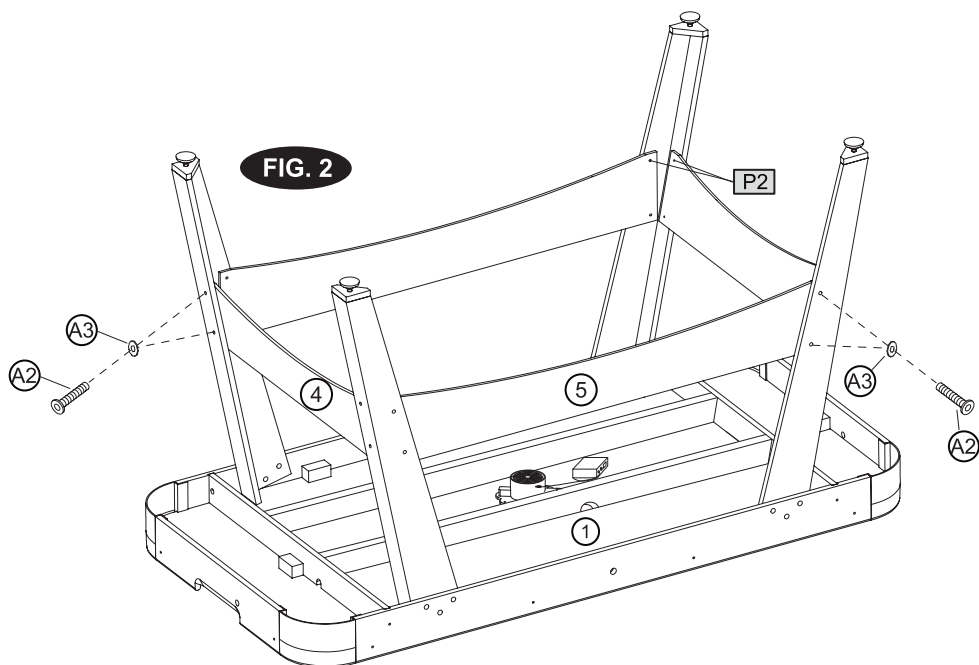

**FIG.1**

3. Place the Mainframe (#1) face down on a clean and flat surface. Attach the Right Leg (#2) and Left Leg (#3) to the Main Frame using three Leg Bolts (#A2) , thee Leg Washers (#A3) per Leg. See FIG. 1.

4. Screw the Leg Levelers (#12) into the bottom of each leg.

<b>4</b>  X2	<b>5</b>  X2	<b>A2</b>  X16	<b>A3</b>  X16	<b>P2</b>  X16
---	---	---	---	---



**FIG.2**

5. Attach the Leg Side Panels (#5) to the Legs using four Leg Bolts (#A2), four Leg Washers (#A3) per Leg Side Panel.

6. Attach the Leg End Panels (#4) to the Legs using four Leg Bolts (#A2), four Leg Washers (#A3) per Leg End Panel.

7. Lift the table assembly from the floor with two adults, turn it over, and set table on its leg in the location where you will play.

Go back and make sure that all connections are tight.

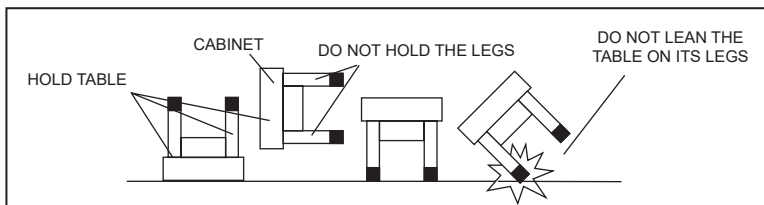

**CAUTION:** Two strong adults are recommended to turn the table over as shown.

1. Lift the table off the ground.
2. Turn the table over.
3. Place it on all four feet at the same time on the ground.

<b>6</b>	<b>8</b>	<b>9</b>	<b>10</b>	<b>11</b>	<b>A4</b>	<b>A5</b>
<b>X1</b>	<b>X2</b>	<b>X2</b>	<b>X2</b>	<b>X1</b>	<b>X4</b>	<b>X2</b>

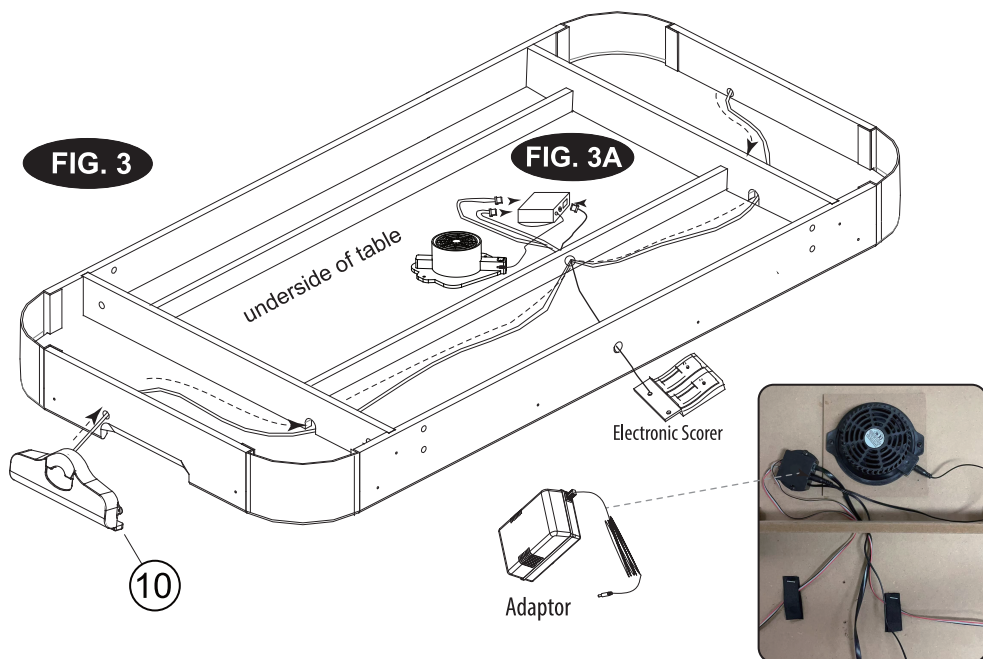

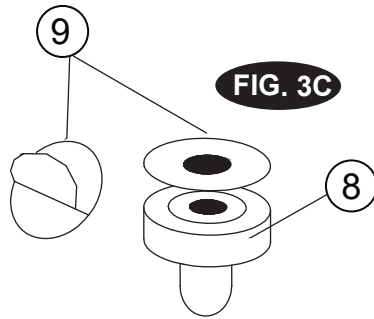
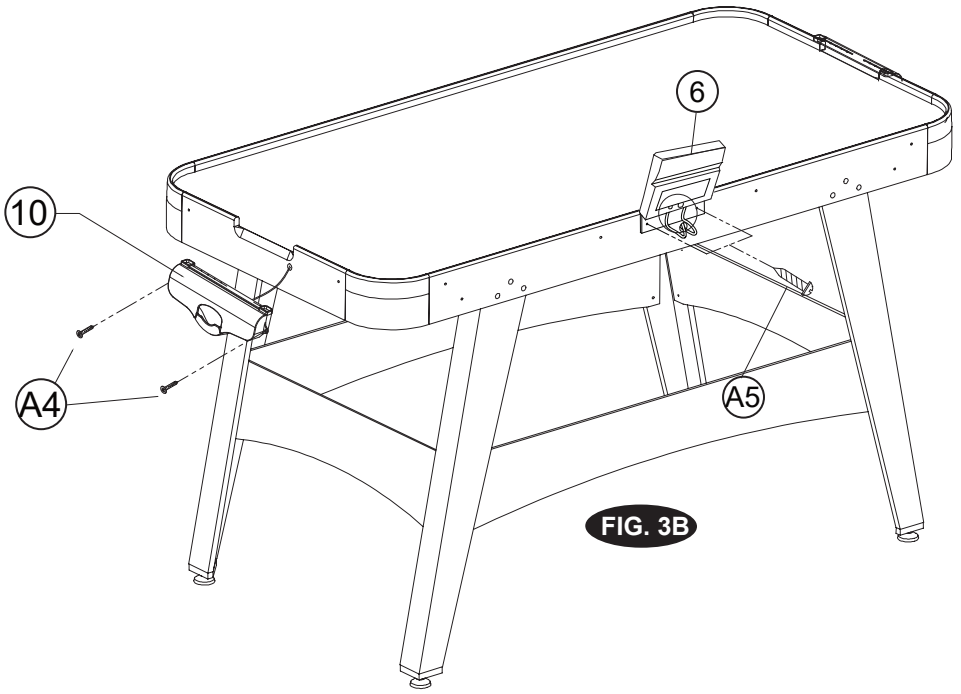

### FIG.3

8. Thread the wire from Goal Box (#10) through the openings of the end aprons and alongside the play-field's support beams to the opening of side apron and use Velcro Straps to fix Scorer Wire. See FIG. 3A
9. Attach the Goals Boxes (#10) to each End Apron using two Screws (#A4). See FIG. 3.
10. Attach the Electronic Scorer (#6) to the side apron in the pre-drilled holes using two Screws (#A5). Insert the Scorer Wire into the Electronic Scorer (#6). See FIG. 3 & 3B.
11. Tear off the backside paper of the Felt Pad (#9) and stick them on the bottom of the Pushers (#8). See FIG. 3C.
12. Insert the Adaptor (#11) into the Connection box (#P5). See FIG. 3D.

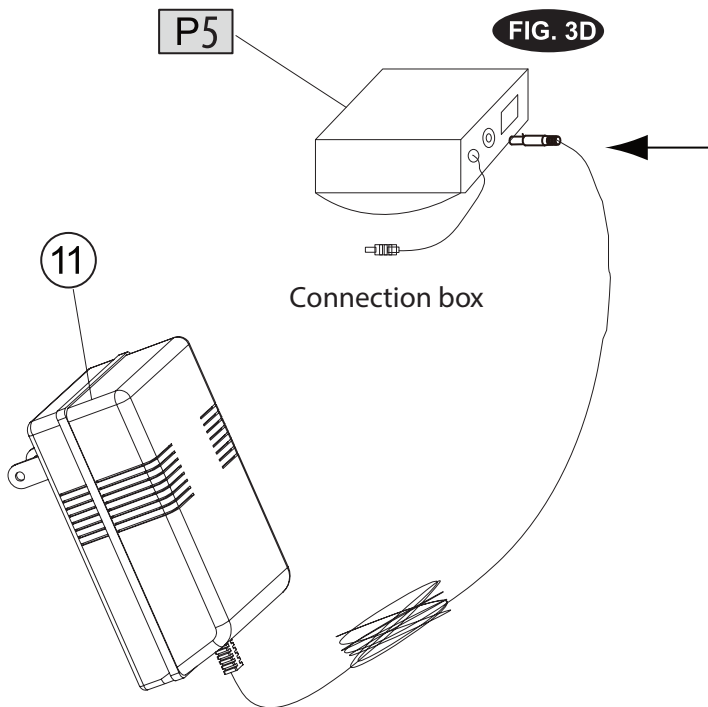



## ELECTRONIC SCORER OPERATION

### 1. Reminder:

If connected in series, when you turn off the scorer, the fan will turn off at the same time. Also when the scorer is unavailable in five minutes, it will go to sleep, then the fan will go to sleep and stop too.

2. When the "HOME" player scores a point, the "HOME" indicator will show 1 point; when the "VISITOR" player scores a point, the "VISITOR" indicator will show 1 point.
3. The first player to reach 10 points wins the game, and the winner's indicator will stay at 9 points and flash for several seconds.
4. After the game, you can press the "RESET" button to start a new game and the HOME/VISITOR will indicate "0".

### Note:

1. You can press the "RESET" button at any time, to set the scorer back to the beginning status.
2. You can press "ON/OFF" at any time to turn off the scorer.  
Press "ON/OFF" again to turn it back on.

### CAUTION-ELECTRICALLY OPERATED PRODUCTS

Volt: INPUT:120V-50/60HZ OUTPUT:12 VDC  $\approx$  0.35A 

CAUTION-ELECTRIC TOY: Not recommended for children under 8 years of age as with all electric products, precautions should be observed during handling and use to prevent electric shock.

This item contains small parts. The parents need to periodically examine for potentially hazardous parts repaired or replaced.

Date of manufacturer: 2018/06/06



serenelife™

**Questions? Comments?**

We are here to help!

Phone: (1) 718-535-1800

Email: [support@pyleusa.com](mailto:support@pyleusa.com)

