

SereneLife
by PYLE

UdIRC®

UPGRADE

- HD video camera
- Low Voltage Warning
- 4GB memory card
- Headless Mode
- Return home function

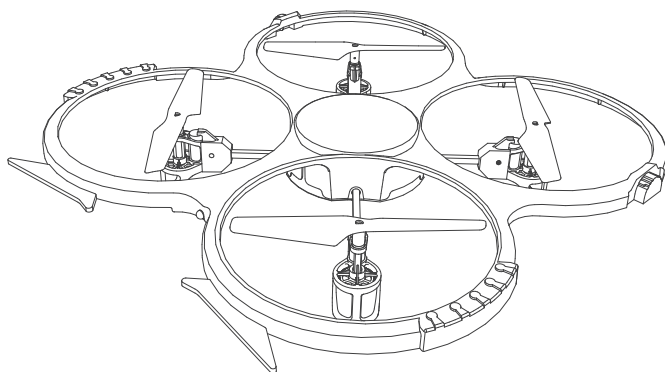

SLDR18HD



Name for parts:

1. Quadcopter

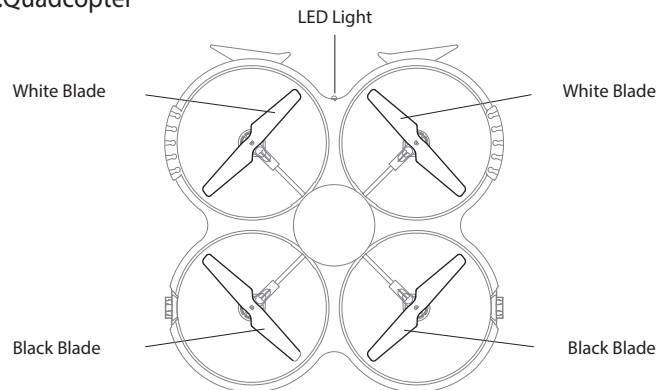

2. Transmitter

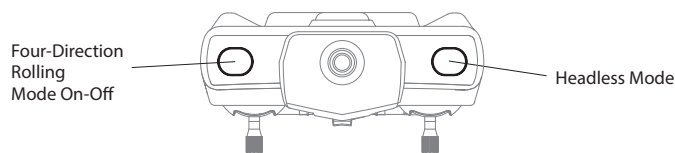
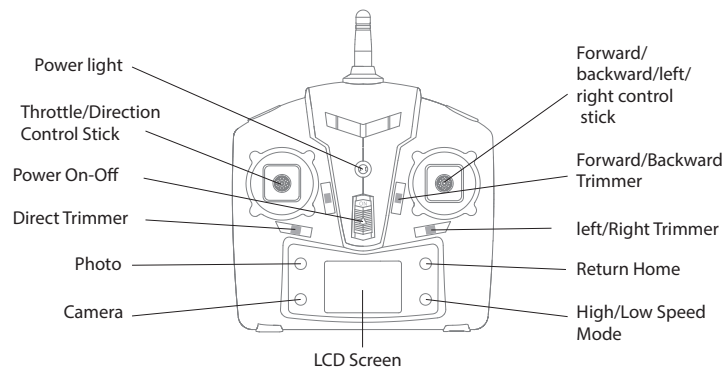

Notice:

1. Instructions

Thank you for purchasing our SLDR18HD + RC Quadcopter. In order to quickly and safely master the operation of the SLDR18HD HD+ quadcopter, please read the user instruction manual carefully and then keep it a safe place for future consultation and maintenance.

1.1 Important Notice

- (1) This product is not a toy, it's a piece of complicated equipment which is integrated with professional knowledge by mechanic, electric, air mechanics, high-frequency transmitter and so on, so it should be installed correctly and adjusted to avoid any accidents. The owner must always operate in a safe manner. If improper operation causes human injury or property damage, then UDIRC accept no liability for any damage from operation as we have no control over the way the quadcopter is maintained, used and operated.
- (2) This product is suitable for experienced RC quadcopter pilots aged 14 years or more.
- (3) The Flight field should be legally approved by the local government.
- (4) We at Udirc accept no liability for any safety duties or fines arising from operation, usage or mis-control after the sale of products.
- (5) For technical support, operation, maintenance, etc, please contact the local distributors in your country, we have consigned to them service after sale.

1.2 Safety Precautions

Keep away from crowd when flying, since RC quadcopter flight is a high risk hobby. Mis-assembled or broken main frame or defective electronic equipment or unskilled operation may cause accidents of machine damage or injuries. Please pay special attention to safety operation and have good knowledge of accident responsibility that the pilots may cause.

- (1) Keep away from people and obstacles

"The flying speed and status of RC quadcopter is uncertain, so it may cause potential danger." When choosing a flying site, stay clear of buildings, trees and power lines. AVOID flying in or near crowded areas. Meanwhile avoid flying in rain, storms, thunder and lightning to protect machinery and parts out of damage.

- (2) Keep away from humid environments

Inside of quadcopter is made up of precise electronic components, it must be kept away from humidity or water vapor to protect machinery and parts.

- (3) Safety operation

Please fly your quadcopter according to your physical status and flight skill. Fatigue, listlessness and mis-operation will increase possibilities of accidental hazard.

- (4) Keep away from rotating blades

Keep your face and body as well as all spectators away from the rotating blades. The spinning blades of a model of this type can cause serious injury.

- (5) Keep away from heat

A RC quadcopter is made up of metal fiber plastic, electronic components, etc. So we must try to keep it away from heat and sunshine to avoid distortion, even damage.

1.3 Check List Before First Flight

- (1) Flying field should be in an open space and we suggest at least 5M length * 5M width * 3M height.
- (2) Make sure the receiver and transmitter are fully charged.
- (3) Please strictly obey the order of turn-on, turn-off before operation. When starting your flight, first turn on the transmitter, and connect power cable of quadcopter last; When finishing your flight, please disconnect the power cable of your quadcopter, first turn off transmitter last. A change in the order of connection may cause your quadcopter to lose control to threaten yourself and others safety. Please cultivate a correct habit of turn-on and turn-off.
- (4) Make sure the connection is solid between battery and motor. The ongoing vibration may cause bad connection of power terminal and out of control for quadcopter.

Transmitter battery installation:

Open the battery compartment cover of transmitter, install the battery into box according to electrode instructions (Batteries not included).

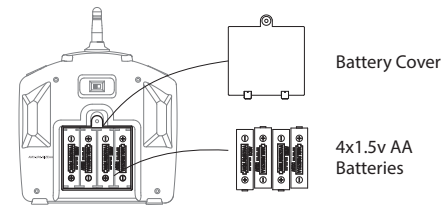

Notice:

1. When install the battery, you must obey the electrode instructions, and loaded reverse is not allowed.
2. Please don't mix new and old battery together.
3. Please don't use different kinds of batteries.

Charger notice:

1. Connect 1 or 2 batteries to the balance charger and then connect USB to computer.

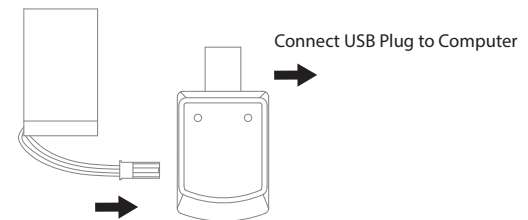

- The red indicator light keeps bright when charging. When fully charged the red indicator light off and the green indicator light keeps bright.

Warning: Please only use equipped charger to charge the Lipo battery.



LiPo Battery Disposal & Recycling



Lithium-Polymer(LiPo) batteries must not be placed in with household trash. Please contact your environmental or waste agency or the supplier of your model for local regulations and the location of your nearest LiPo battery recycling center.

Calibration instructions:

When the quadcopter takes off hovering can't be adjusted by trim and causes difficult operation, then please adjust the quadcopter according to below steps:

- Pull out the power of quadcopter, power off the transmitter;
- Power on the transmitter, push the throttle stick to utmost and then back to lowest position.(see pic 1/2),then the transmitter is ready to code pairing.

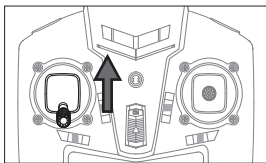

Picture 1

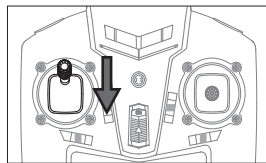

Picture 2

- Power on the quadcopter and put it on a level surface, about 3 seconds later, you will hear "di,do,di", and it shows code pairing successful.
- It's not allowed to push the throttle stick before adjustment. Operate the transmitter stick forward and backward/ left and right to the lower right corner (see pic 3), then quadcopter gets a solid light and no more flashing, it shows adjustment finished and quadcopter is ready to fly.

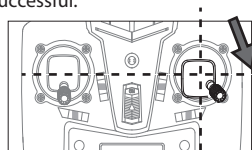

Picture 3

Flying operation:

- Power on transmitter,the LED indicator begins flashing. Push up throttle stick to top end and then pull down to low end, the indicator gets a solid light. It shows transmitter is ready for code pairing with receiver.
- Install the batteries to the battery box and power on the drone.
- Put the quadcopter on the flat ground,when blue light stops flashing and is stable, then the quadcopter is ready to fly.

Important notice:

When powering on the quadcopter the receiver gyro will need to calibrate level, so you must make sure the surface is level. Then the quadcopter will be ready for controlling.

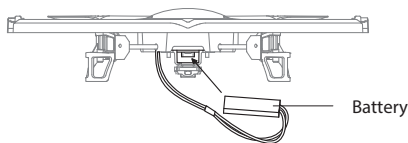

Battery installation and power connection for quadcopter

Additional instruction before flying:

1. White blade is at front and black blade is at back.

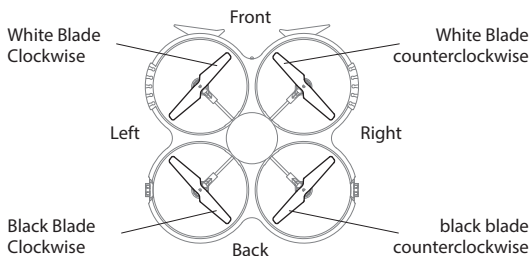

2. Power on the quadcopter check the rotating of blades. Left Front/Right rear blades rotating Clockwise, Right front/Left behind rotating Counterclockwise.
3. When flying, if the quadcopter tilts to one side, then you can adjust balance by relative trim key.
4. When the quadcopter battery is low, then the transmitter will sound DI, DO, DI... to warn. When you receive the warning, then you need to remote back the quadcopter within 40 seconds.

Flying control:

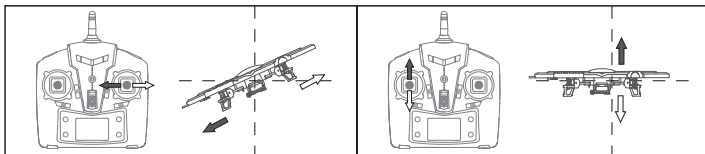

1. When moving throttle stick to left or right, then the quadcopter is flying left or right at the same time.
2. When moving throttle stick up or down, then the quadcopter is flying up or down at the same time.

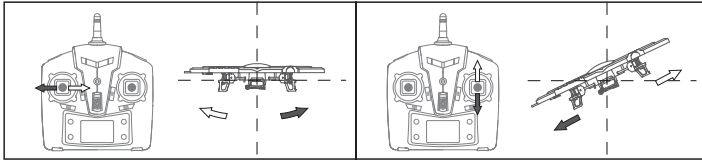

3. When moving forward and backward/ left and right flying stick to left or right, then the quadcopter is flying to left or right at the same time.

4. When moving forward and backward/ left and right flying stick to front or back, then the is flying forward or backward at quadcopter the same time.

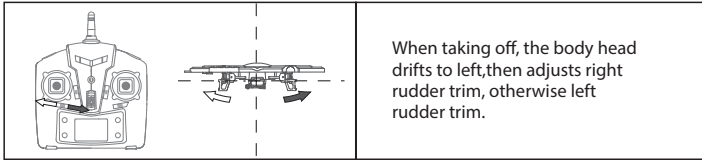

5. Adjust left and right rudder trim

When taking off, the body head drifts to left, then adjusts right rudder trim, otherwise left rudder trim.

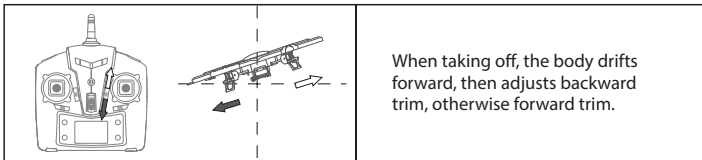

6. Adjust forward and backward trim

When taking off, the body drifts forward, then adjusts backward trim, otherwise forward trim.

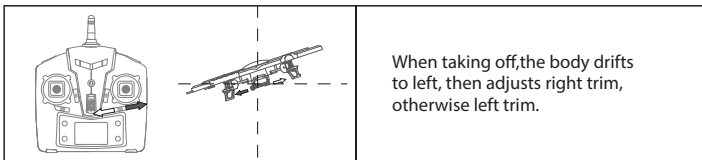

7. Left & right trimmer

High/low speed mode

This quadcopter comes with high and low speed modes, press down the high and low speed button in the transmitter, then LCD display screen will show switch for MODE1 and MODE2.

MODE 1 (Low speed mode, suitable for beginner)

MODE 2 (High speed mode, suitable for RC enthusiast)

Flip: (When quadcopter bottom light gets flashing, then it's not allowed to flip)

1. When quadcopter is flying in the air, press down the flip button in the lower right corner of transmitter, then the quadcopter will flip 360 degrees.

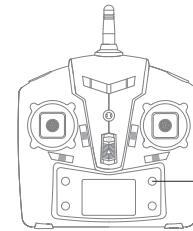

Press This Button

2. When quadcopter is flying in the air, then left hand press down the flip mode switch in the upper left corner of transmitter, then transmitter will sound "DI, DI...", it shows that quadcopter is ready to flip. Use your right hand to push the rudder stick to utmost, then release, the quadcopter will flip 360 degrees to forward and backward or left and right side simultaneously. Meanwhile the flip mode will automatically shut down.

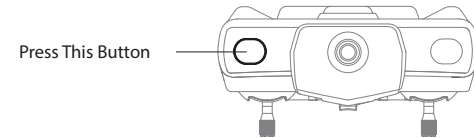

Press This Button

Warning: enough room is need for this motion, or danger may occur.

Headless mode:

Press Headless Mode button, the LED light of drone goes off. This indicates that Headless Mode is on.

Press the Headless Mode button again, the LED light of drone turns on. This indicates that Headless Mode is off.

NOTE: When the drone is in Headless Mode, the head of drone must face towards the front. While in Headless Mode, if the direction and angel of drone is offset, you can exit from Headless Mode and then turn Headless Mode on again. This will cause the direction and angel to reset to normal status.

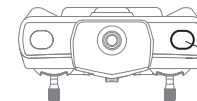
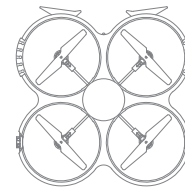

Press This Button

During normal flight, the head of the drone is towards the front. Pressing the Headless Mode button, the LED light of the drone body turns off. This indicates that Headless Mode is activated. There is no direction to distinguish the front and back of the drone when flying.

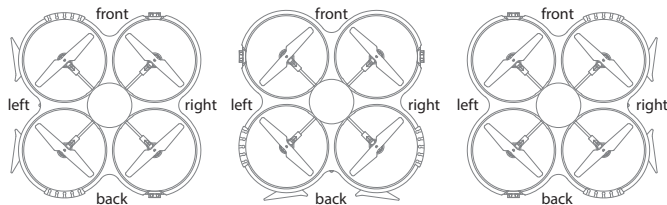

Return Home Function:

When the drone flies a long distance away, you can press the Return Home button and the drone will return home (location from where it took off) automatically. Move the right side control stick forward and backward / left and right, then the drone will stop returning.

Important:

The Return Home function only works when Headless Mode is turned on

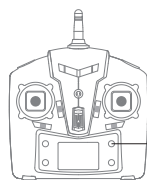

Press This Button

Additional instructions for receipt board:

Please make sure the install direction and wire-plus position should be the same as the following picture or the quadcopter cannot work normally

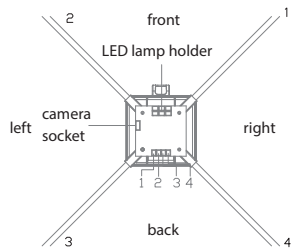

receipt board socket 1, connect with right-front electric wire
 receipt board socket 2, connect with left-front electric wire
 receipt board socket 3, connect with left-back electric wire
 receipt board socket 4, connect with right-back electric wire

How to take video & photo:

1. Install TF card to the camera, press TF card to insert, notice the TF card metal touch place and insert the TF card according to the sketch map.
2. When pressing down the camera button, the LED indicator will flash once, showing that the quadcopter is taking pictures. When press down the video and the LED indicator keeps flashing, then it's recording video. if you need to button stop recording, then press the video button again, and the LED indicator will stop flashing, thus finishing a video .When you press the TF card again,you can pick up the card.

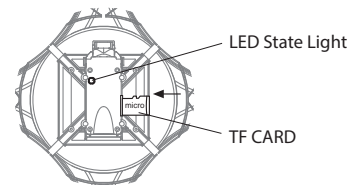

3. When Aerial is over, please disconnect the quadcopter and battery. Pull out the TF card,put the TF card into the reader,then connect the USB to computer. A few seconds later, you will find the Mobile hard disk from my computer and then you can see aerial data.















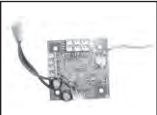

Notice: Please make sure broadcast the video after copied data to computer and the video broadcast software format only support AVI.

Aerial Camera parameters as below:

Video resolution: 1280*720P/30fps; Camera resolution: 1280*720

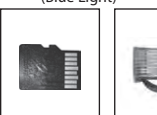
Spare Parts:

Below are spare parts for your selection,for more convenience,we listed each spare part you would buy through local distributors.

			
SLDR18HD-01 Main Shelf	SLDR18HD-02 Blade	SLDR18HD-03 Head Cover	SLDR18HD-04 Charger Box
			
SLDR18HD-05 Receiver	SLDR18HD-06 Standard Motor (Red/Blue)	SLDR18HD-07 Reverse Motor (Black/White)	SLDR18HD-08 Clockwise Motor Set (Red Light)
			
SLDR18HD-09 Clockwise Motor Set (Blue Light)	SLDR18HD-10 Counter-Clockwise Motor Set (Red Light)	SLDR18HD-11 Counter-Clockwise Motor Set (Blue Light)	SLDR18HD-12 Camera Box
			
SLDR18HD-13 TF Card	SLDR18HD-14 Battery	SLDR18HD-15 Gear Holder	SLDR18HD-16 Transmitter
			
SLDR18HD-17 Reader			