

48" Competition Sized Foldable Foosball Table

Arcade Table Soccer for Home & Game Room
with 2 Balls

serenelife™

USER GUIDE

Features:

- Foldable Tabletop Foosball Table
- Heavy Duty for Pub Game Tournament
- Durable and Compact Game Table
- High-Quality Metal Hardware
- Mini Foosball Table for Kids and Adults
- Chrome Plated Tubular Steel Rods with Plastic Handles
- Easily Turn to Kick and Block the Ball
- Some Assembly Required
- Luxury and Modern Design
- Plastic Bearing
- Height Adjustable Table Feet



What's in the Box:

- Foldable Foosball Table
- (2) Black/White Soccer Balls

Technical Specs:

- Construction Material: ABS (Handle), MDF with PVC (Legs)
- Number of Balls: 2
- Number of Drink Holders: 2
- Playfield: 0.18" MDF
- Side/End Panel: 1/2" Thickness
- Player: Painting Player 1-2-5-3
- Steel Rods Dimension: 1/2-inch Diameter
- Product Dimensions: 47.83" x 24.02" x 30.7" -inches

⚠️ WARNING **CHOKING HAZARD**

Toy contains small pieces,
Not for children under 3 years.
Adult supervision required.

California Prop 65 Warning

⚠️ WARNING:

This product contains Wood Dust which is known to the state of California to cause cancer birth defects and other reproductive harm. Do not ingest.

For more info go to: www.P65warnings.ca.gov











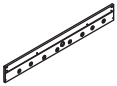
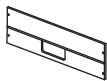
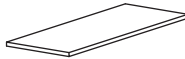
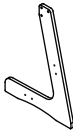



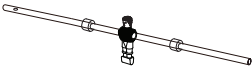
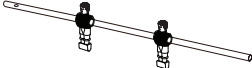
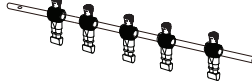
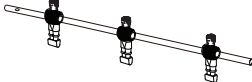
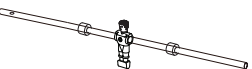
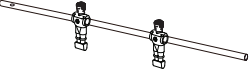
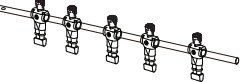
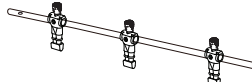

Questions? Comments?

We are here to help!

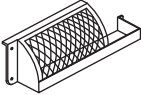
Phone: (1) 718-535-1800

Email: support@pyleusa.com

PARTS LIST

<p>#1</p>  <p>Long Side Boards (2)</p>	<p>#2</p>  <p>Short Side Boards (2)</p>	<p>#3</p>  <p>Playfield (1)</p>	<p>#4</p>  <p>Type Leg (2)</p>
<p>#5</p>  <p>Leg (2)</p>	<p>#6</p>  <p>End Leg Brace (3)</p>	<p>#7</p>  <p>Support Braces (2)</p>	<p>#8</p>  <p>Screws (24)</p>
<p>#9</p>  <p>1-player rods-black (1)</p>	<p>#10</p>  <p>2-player rods-black (1)</p>	<p>#11</p>  <p>5-player rods-black (1)</p>	<p>#12</p>  <p>3-player rods-black (1)</p>
<p>#13</p>  <p>1-player rods-white (1)</p>	<p>#14</p>  <p>2-player rods-white (1)</p>	<p>#15</p>  <p>5-player rods-white (1)</p>	<p>#16</p>  <p>3-player rods-white (1)</p>
<p>#17</p>  <p>Bolt (4)</p>	<p>#18</p>  <p>Washer (4)</p>	<p>#19</p>  <p>Screws (8)</p>	<p>#20</p>  <p>Hand grip (8)</p>
<p>#21</p>  <p>End caps (8)</p>	<p>#22</p>  <p>Goal (2)</p>	<p>#23</p>  <p>Soccer Balls (4)</p>	<p>#24</p>  <p>Allen wrench (1)</p>
<p>#25</p>  <p>Washer (12)</p>	<p>#26</p>  <p>Rubber Bushing (16)</p>	<p>#27</p>  <p>Wing Bolt (4)</p>	

ASSEMBLY INSTRUCTIONS

STEP 1

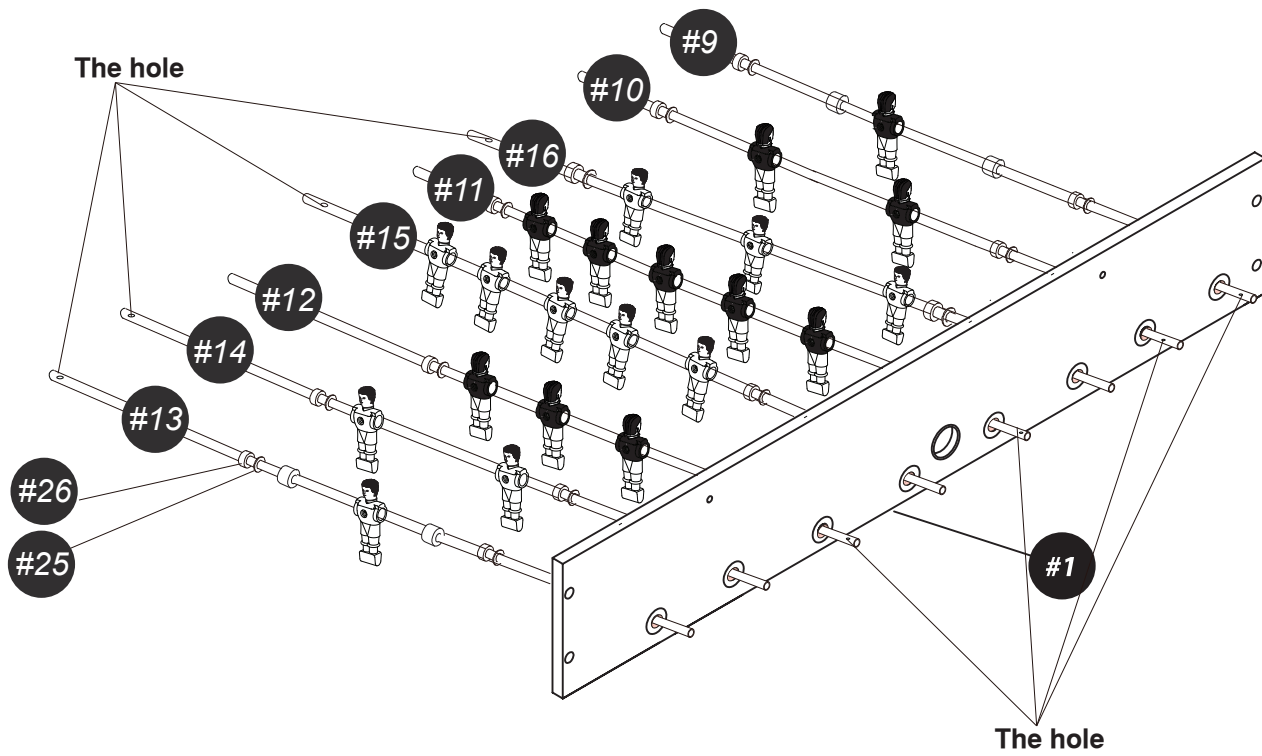

STEP 2

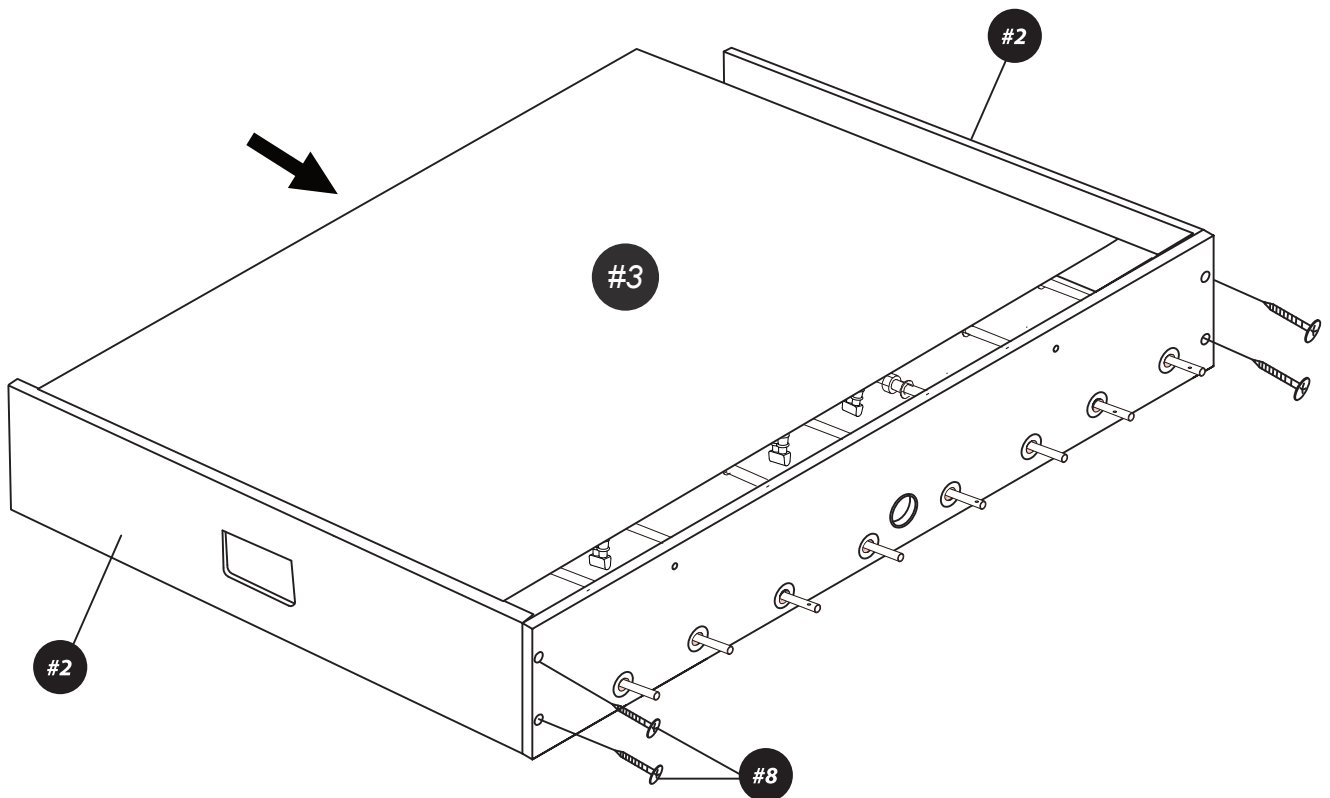

ASSEMBLY INSTRUCTIONS

STEP 3

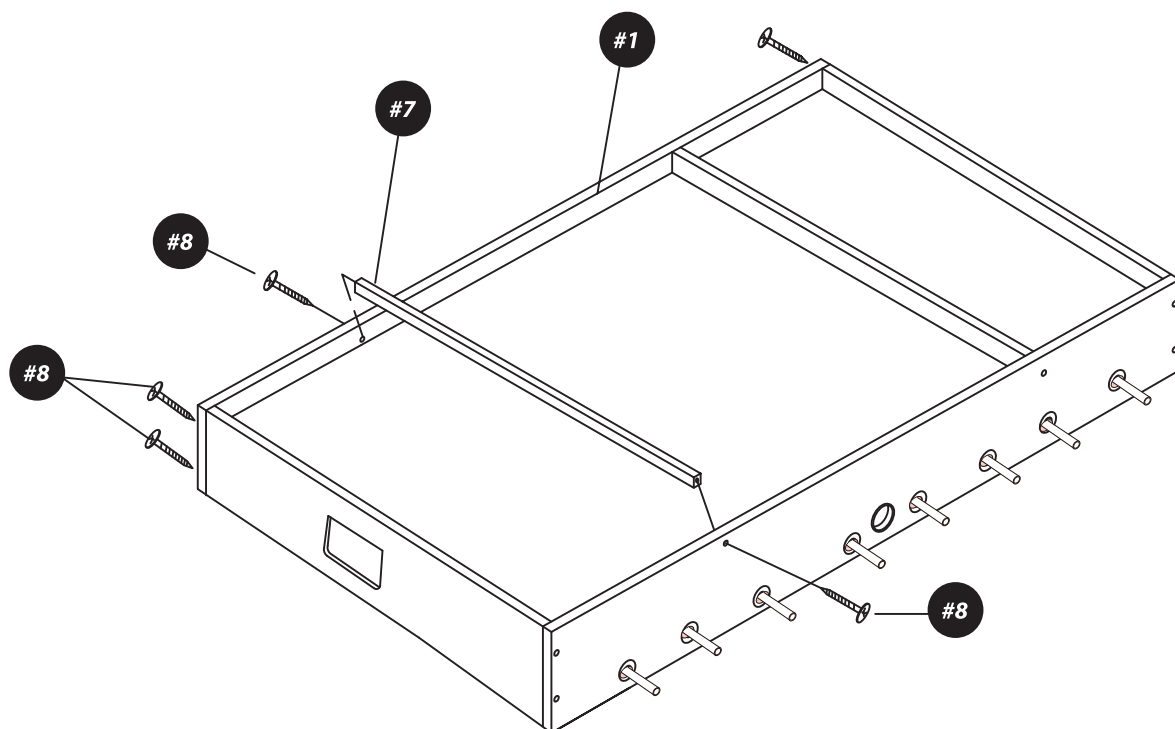

STEP 4

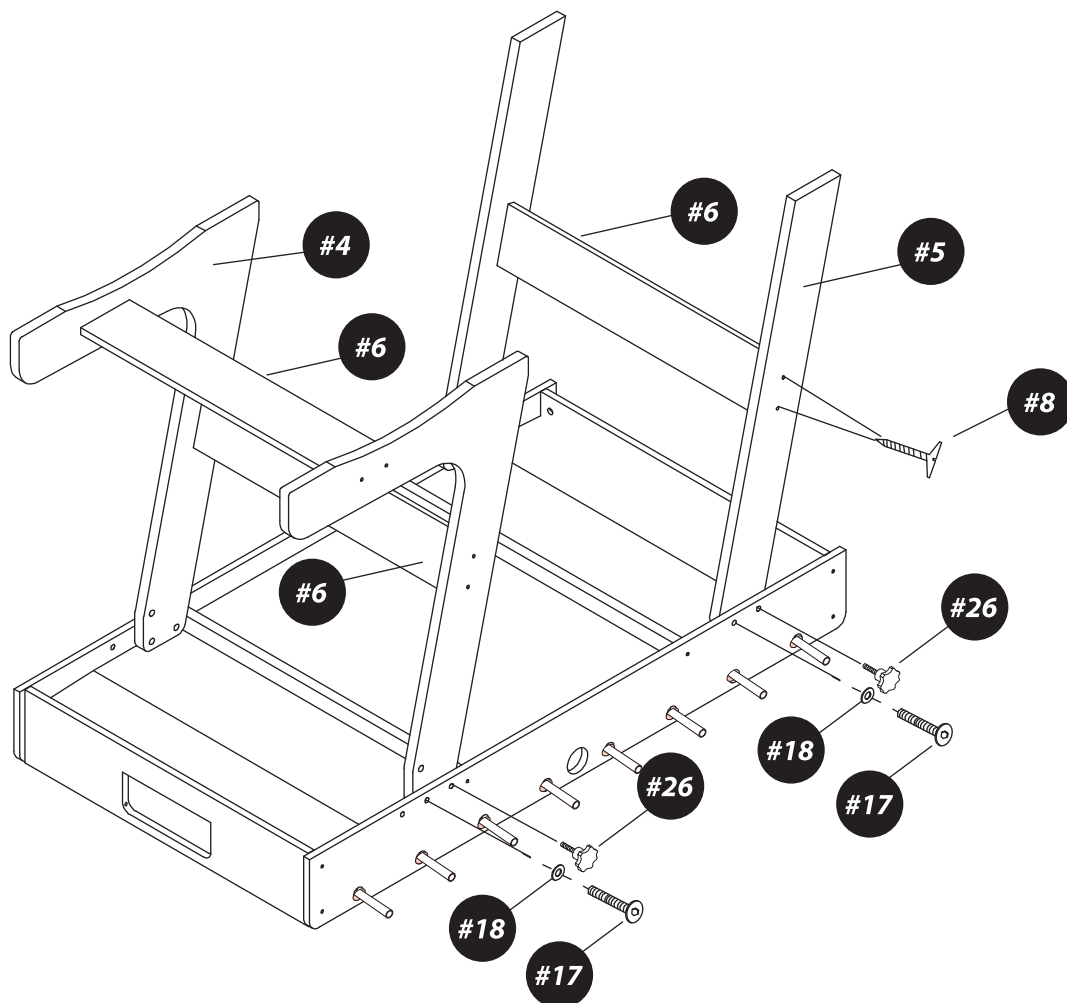

ASSEMBLY INSTRUCTIONS

STEP 5

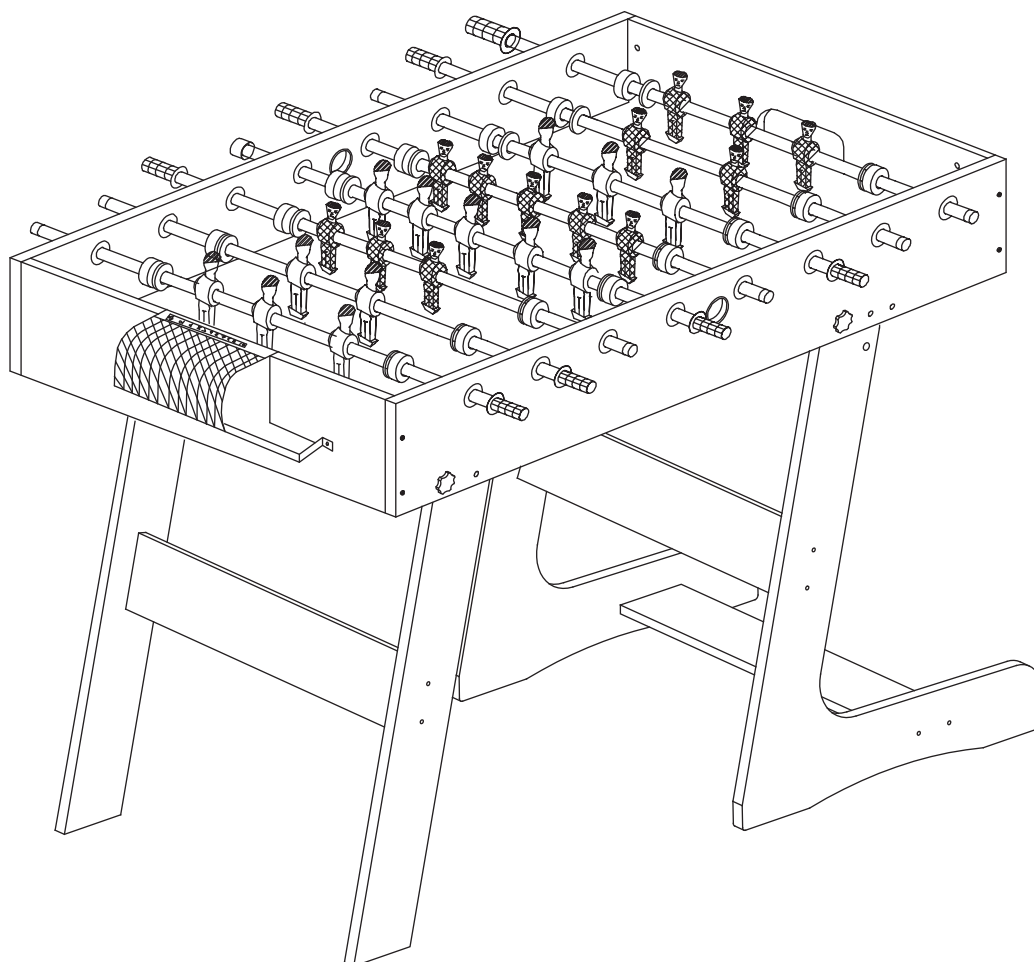
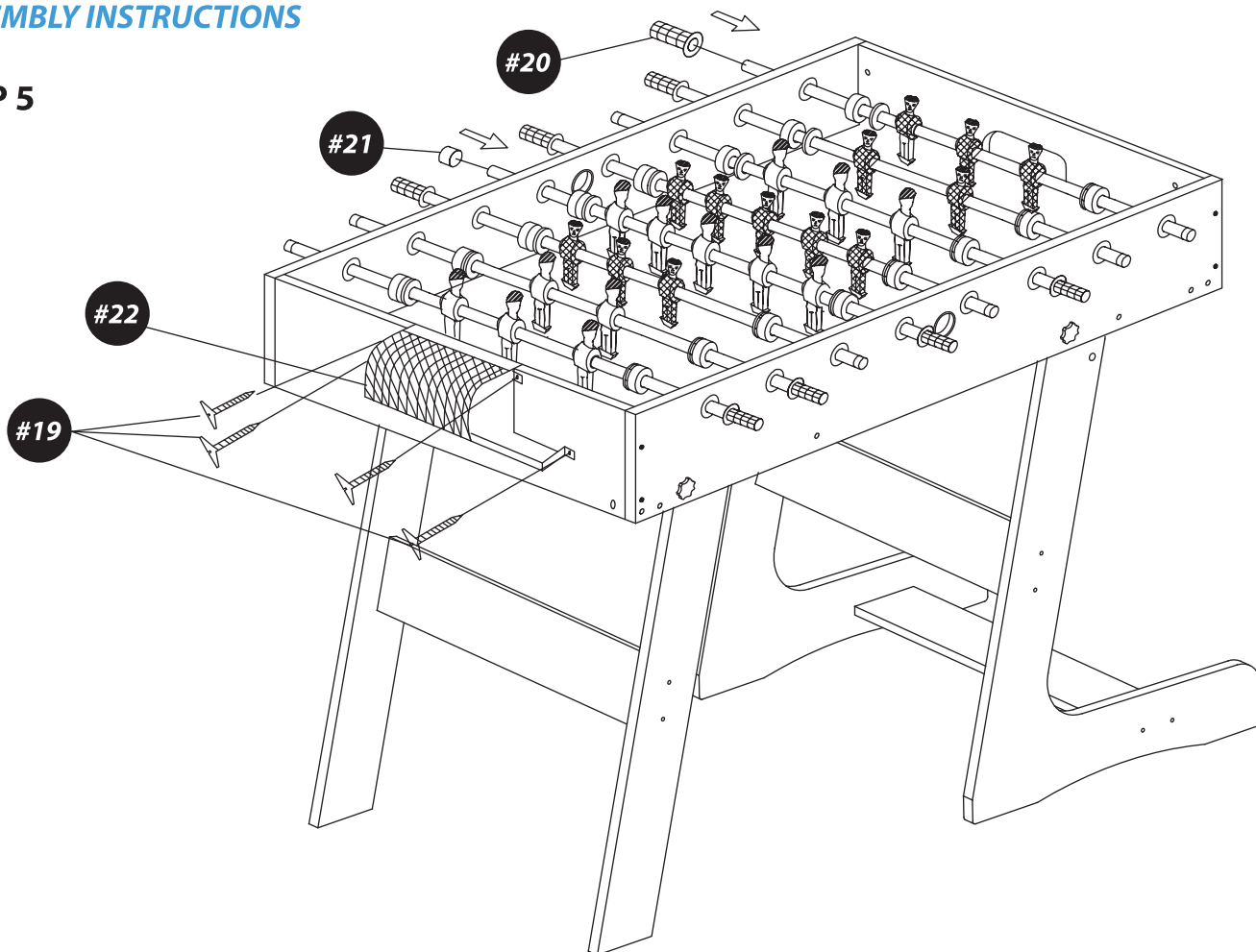

FOOSBALL TABLE GAME RULES

TO START A MATCH

A coin flip shall precede the start of the match. The team that wins the flip has the choice of table side or first serve.

THE SERVE

A serve through the serving hole is used to put the ball into play at the start of the match, after a point is scored, or after a ball leaves the table.

SUBSEQUENT SERVES

Following the first serve of the match, subsequent serves shall be made by the team last scored upon.

BALL IN PLAY

Once a ball is put in play by the server, it shall remain in play until the ball is hit off the table, a dead ball is declared, time out is called, or a point is scored.

BALL OFF THE TABLE

The ball should be put back into play with a serve by the team which originally served that ball.

DEAD BALL

A ball shall be declared dead when it has completely stopped its motion and is not within reach of any player figure. If the ball is declared dead between the goalie and the 2-man rods, it shall be put back into play by placing the ball in the corner nearest the spot of the dead ball. If the ball is declared dead anywhere else on the table, it shall be put back into play with a serve by the team that originally served that ball.

POINT SCORED

A ball entering the goal shall count as a point, as long as it was legally scored.

A ball which enters the goal but returns to the playing surface and/or leaves the table still counts as a goal.

CHANGE OF POSITIONS

In any doubles event, each player may play only the two rods normally designated for his position.

Once the ball is put into play, the players must play the same position until a point is scored.

SPINNING THE RODS

Spinning the rods is illegal. Spinning is defined as the rotation of any soccer figure more than 360 degrees before or after striking the ball. If the ball goes in the goal, then it will not be counted as a point and will be put back into play by the goalie as if the ball had been declared a dead ball between the goal and the nearest two-man rod.

JARRING

Any jarring, sliding, or lifting of the table shall be illegal.

REACHING INTO THE PLAYING AREA

It is illegal for a player to reach into the playing area while the ball is in play.