

serenelife™

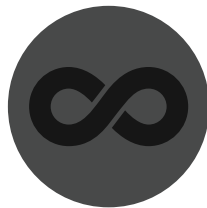

Questions? Issues?
We are here to help!
Phone: (1) 718-535-1800
Email: support@pyleusa.com

serenelife™



SLIB930



SLIB940



SLIS910



SLIS920

User Manual

**WARNING: FAILURE TO FOLLOW THESE INSTRUCTIONS
COULD RESULT IN SERIOUS INJURY OR DEATH.**

STEP 1 SAFETY PRECAUTIONS

WARNING! This product should be inflated or deflated only by a competent adult. Use only under adult supervision. Follow all instructions provided.

- Keep power cord away from water.
- Keep away from fire. Keep fabric clear of all flame and ignition sources.
- Keep children away from blower. The blower is not a toy.
- Do not use extension cords with this product.
- Do not set up in windy or rainy conditions.
- Set up as close to power sources as possible.
- The blower should be securely anchored to the ground before use.
- Product should never be dragged across concrete, pavement or other rough surfaces.
- Always inspect inflatable for holes and open seams before each use.
- Do not insert fingers, toes, etc into the blower, or it may cause injury.
- Do not insert foreign objects into the blower. This will cause damage.
- Do not bring sharp objects into play area. Avoid and remove all head gear, loose clothing, hard, sharp, or dangerous objects, such as, but not limited to: jewelry, ponchos, scarves, helmets, etc.
- Do not eat, drink or chew gum in play area.
- When using slides, slide feet first, never head first. Always make sure slide is clear of others before sliding. Only one user may slide at a time.
- Never stand up on slide platform. Prevent children from climbing or hanging on the containing walls.
- Do not leave unit inflated or outside when not in use.
Prolonged exposure to sun or strong weather will destroy fabric.
- Avoid rough play, such as somersaults, flips, wrestling and gymnastic moves, etc.
- Rough play is dangerous for children and can damage the unit.

- Do not use in direct sun in temperatures above 90 degrees Fahrenheit.
Direct exposure to sun can heat surfaces to unsafe temperatures for play.
- Do not attach items to the inflatable device that are not specifically designed for use with the inflatable device, such as, but not limited to, jump ropes, clothesline, pet leashes, cables and chain as they have the potential to cause a strangulation hazard.
- Players should be evenly matched in size and abilities, to minimize injury risk.
- When climbing platforms, always climb in an upright position, placing feet in foot holes, and placing hands on support handles.
- Only for domestic use. Intended for outdoor domestic family use only.
Not for use in public areas or as a rental.
- Set-up in outdoor location only that meets the following criteria:
 - Place on level ground and firm grass or soil to allow proper use of stakes.
 - Stakes should be placed at an angle for better anchorage, should be driven under the ground to prevent tripping.
 - **Minimum clearance zones 6.6 ft (2 m) in any direction:**
Place at least other objects. Objects to be avoided include but are not limited to fences, buildings, trees, overhead branches, laundry lines, electrical wires, walls, or bodies or sources of water.
 - Make sure the area around the product is secure by adding safety barriers, if necessary, to keep young children and pets from gaining access.
 - Electrical cord must not be passed under the air filled devices (inflatable bouncer) and interfere with its operation.

STEP 2 INSTALLATION GUIDE

SET UP

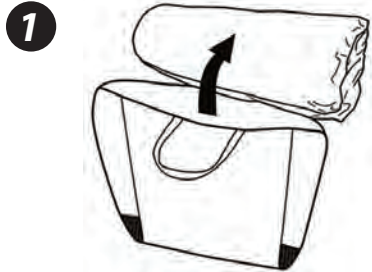

Take out the inflatable unit

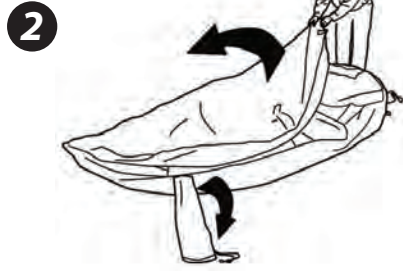

Fully spread out and find the position of the air inlet tube.

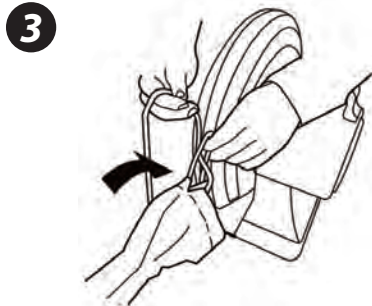

Attach fabric tube to blower unit making sure the tube is not twisted.

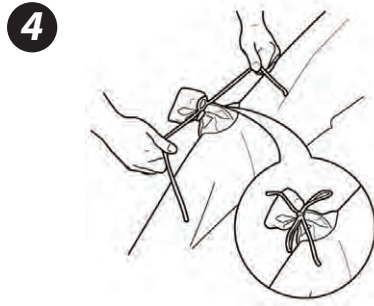

Tie off the short tube as shown.

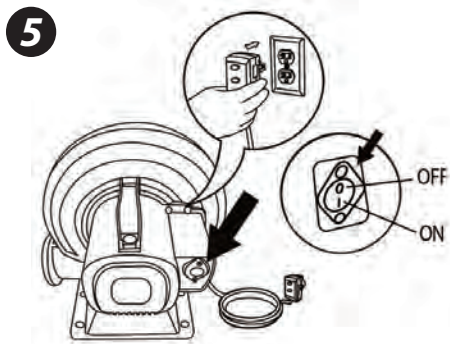

Plug in the power and turn on the blower.

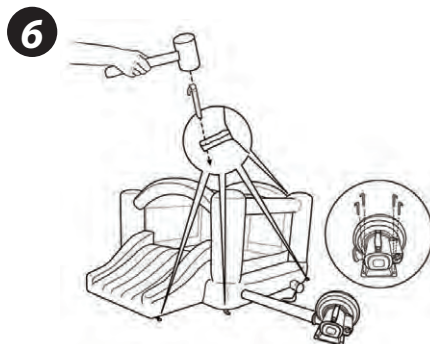

Anchor the bouncer with stakes.

DEFLATION & STORAGE

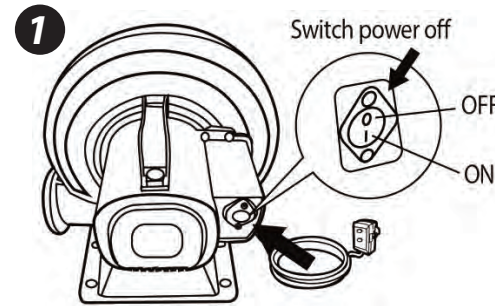

Turn off the blower and unplug it from the outlet.

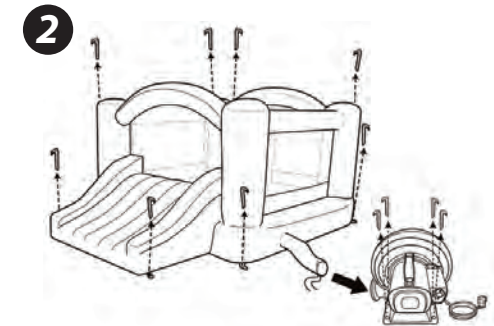

Pull up the stakes

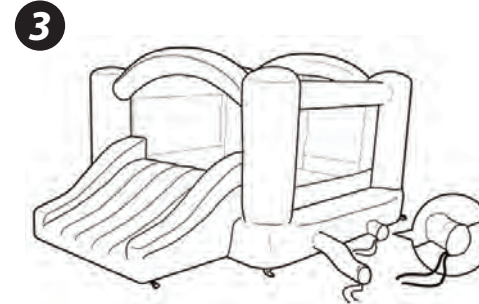

Untie drawstring from the intake Tube and allow the bouncer to fully deflate.



Fold up



Compress air out as you are rolling up inflatable.

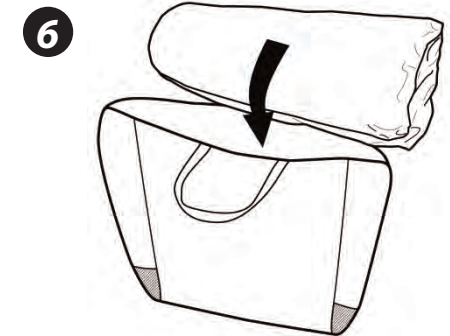

Put in storage bag and store in dry and ventilated place.

ADDITIONAL INSTRUCTIONS FOR WATER UNIT

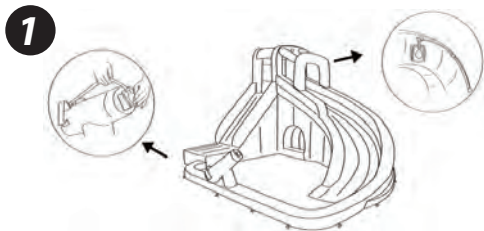

Fix the sprinklers on water cannon and the top of the inflatable unit.

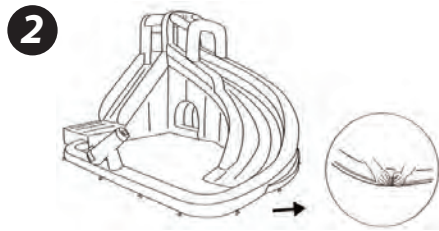

Secure the water tube with the attached Velcro ring.

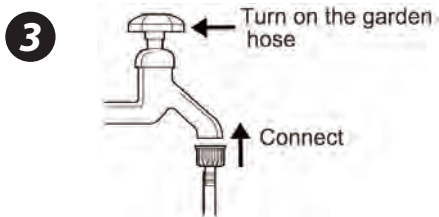

Connect it from the clear plastic tubing and turn on the garden hose.

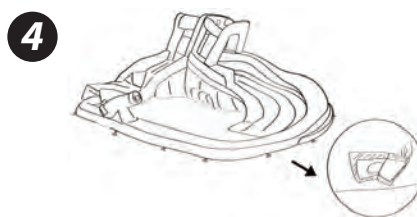

Tear off the Velcro at the bottom to let the water fully flow out when deflating.



Safety Warnings: FAILURE TO FOLLOW THESE INSTRUCTIONS COULD RESULT IN SERIOUS INJURY OR DEATH.



Maximum player: 3



Total weight limit:
300 lbs (136 kg)



Individual weight limit:
100 lbs (45 kg)



Maximum individual
height: 5 feet (152 cm)



Adult supervision required



Age



No sharp objects



No shoes, no glasses



No flipping



No head-first sliding.
Always slide feet-first.



No wrestling



No hands or feet on net



Do not use in windy
conditions



Do not leave out in rain



Do not allow children to
touch fan or electrical cord



Must be anchored
using stakes

STEP 3 MAINTENANCE

Instructions for Bouncer Maintenance

- As an outdoor product, the bouncer is subject to wear and deterioration. Inspect for signs of fabric failure; weak or torn surfaces must be repaired promptly.
- To keep the product clean: wipe the bouncer or blower using a dry cloth or a cloth dampened with a neutral, non-flammable, non-toxic cleaning and sanitizing solution or pure water.
- Product should never be stored wet. Allow to dry before rolling up.
- The product should be periodically examined for potentially unsafe conditions such as: damaged cord, plug, housing, or parts, and that in the event such damage is found, the product should not be used until properly repaired. Never leave the fan outside in the rain or elements when not in use. Minor repairs can be made using the enclosed repair patches.

Instructions for Blower Maintenance

- Blower must be unplugged before servicing.
- Product should be periodically examined for potentially unsafe conditions such as damaged cord, plug, housing, or parts, and that in the event such damage is found, the product should not be used until properly repaired. If these checks are not carried out, the product could overturn or otherwise become a hazard.
- The blower does not require any lubrication and has no user serviceable parts. Do not attempt to service the blower.
- Do not immerse the fan in water. To clean, wipe with a damp cloth.
- Regularly check the intake and output openings and keep free of dirt, leaves, etc.
- When not in use, store the blower indoors in a dry place.
- Store the blower upright on a stable surface.
- Loosely coil the cord and place it beside the blower.
- When in use, do not place the cord across traffic areas, water or damp areas.
- The blower is a high volume blower, and is capable of moving large volumes of air very quickly. Place the blower in an area where it will not draw in dirt or leaves.
- Do not operate any fan with a damaged cord or plug. Discard fan or return to an authorized service facility for examination and/or repair.
- Do not run cord under carpeting. Do not cover cord with throw rugs, runners, or similar coverings. Do not route cord under furniture or appliances. Arrange cord away from traffic area and where it will not be tripped over.

STEP 4: TROUBLESHOOTING

1. THERE IS WATER INSIDE OF MY UNIT

To thoroughly dry your inflatable, turn off all sprayers, and deflate the unit. Dump All standing water from the unit and shake dry. Once the unit is dry, re-attach the blowers, and re-inflate the unit with the short tube open. Your unit will begin to dry from the inside-out. This is critical to avoiding issues such as mold and mildew, and to prolonging the life of your water inflatable unit. **NEVER STORE WET.**

2. THE UNIT DOES NOT STAY INFLATED

Make sure the blower is on, attached to the long tube of the inflatable and running continuously while the inflatable is being used. Make sure the deflation valve (short tube) is tied shut during use. Make sure the weight of users does not exceed manufacturers specifications.

3. MY INFLATABLE DOES NOT FIT IN ITS CASE

Make sure that all the air is out of the inflatable. Fold the inflatable over every 24 inches, pressing extra air out. Once the inflatable is folded over multiple times to one long run of approximately 24" wide, roll the inflatable from one end to the other, into a "sleeping bag shape," continuing to push excess air out.

4. THERE IS A PUNCTURE HOLE IN MY INFLATABLE

The best way to permanently patch a hole is to use strong thread or fishing line to sew the included patch(s) over the hole. Using glue is a short-term fix only, and may not last.

5. CAN I RENT OUT MY RESIDENTIAL INFLATABLE?

Our residential inflatables are not designed for rental or commercial use.

6. THERE IS AIR AND/OR BUBBLES COMING OUT OF MY INFLATABLE

This is normal. Air must escape for the inflatable to function properly.

7. I HEAR A HISSING NOISE

This is normal. Air must escape for the inflatable to function properly, which may cause a hissing noise.

8. DO WATER SLIDES WORK DRY?

Water slides slide much better wet. Some items have features that may be used wet or dry.

9. I FEEL LIKE MY WATER PARK WASTES WATER

Very little water is required to make the slides function. Our Water Parks have flow restriction, but you may also adjust your water flow at the hose faucet, to allow just enough water for the slides to function.

10. WATER ESCAPES FROM THE SPLASH AREA OF MY INFLATABLE

This is normal.

11. CAN I STORE MY INFLATABLE OUTSIDE?

No, weather conditions will destroy your inflatable if it is left out. Please store inflatable unit in dry and ventilated place.

12. MY BLOWER IS NOT WORKING

Make sure you are using standard 110 power. Blowers do not function on 220. If your Blower is equipped with a GFCI on the plug, make sure the GFCI is on, not in Test Mode. Check your outlet to make sure it is on.

SLIB930

INFLATABLE JUMPING CASTLE

Indoor/Outdoor Portable Bounce House with Mini Slide for Kids

FEATURES:

- Recommended Ages 3 and Up
- Suitable for 2 to 3 kids Play Together
- Easy Install and Safety Design
- Surrounded by Reinforced Net Sidewalls
- Comfortable to Touch
- Adopted High-Quality Sewing Technology
- Clean Easily with Soapy Water
- Durable and Smooth
- Exclusive High-strength Product Material
- Perfect Size with Enough Area for Jumping
- Suitable for Indoor and Outdoor
- Inflates in Less than a Minute
- Easy to Set Up and Take Down
- Anchor or Knot to keep Stability and Safety
- Lab-tested to Ensure Safety and Compliance with the Lead-Free Toys

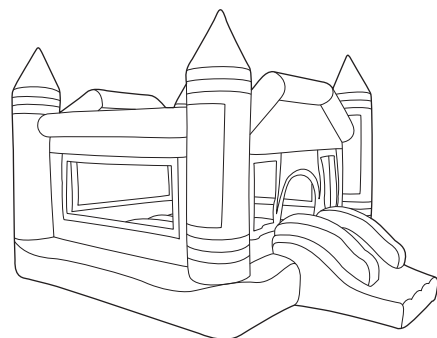

What's in the Box:

- Blower
- Repair Kits
- Plastic Stakes
- Bouncer
- Carrying bag

Technical Specs:

- Construction Material: 420D+840D Nylon
- Maximum Capacity: Up to 300 lbs.
- Recommended Age: 3 and Up
- Heavy Duty Blower: 450W (Recommended)
- Jumping Area Dimension (L x W x H): 92.52" x 112.21" x 15.75" -inches
- Slide Area Dimension (L x W x H): 35.43" x 36.22" x 19.69" -inches
- Overall Product Dimension (L x W x H): 141.73" x 110.24" x 90.55" -inches (Inflate)
- Product Dimension (L x W x H): 15.75" x 15.75" x 14.17" -inches (Deflate)

SLIB940

INFLATABLE JUMPING CASTLE

Indoor/Outdoor Portable Bounce House with Mini Slide for Kids

FEATURES:

- Recommended Ages 3 and Up
- Suitable for 2 to 3 kids Play Together
- Easy Install and Safety Design
- Surrounded by Reinforced Net Sidewalls
- Comfortable to Touch
- Adopted High-Quality Sewing Technology
- Clean Easily with Soapy Water
- Durable and Smooth
- Exclusive High-strength Product Material
- Perfect Size with Enough Area for Jumping
- Suitable for Indoor and Outdoor
- Inflates in Less than a Minute
- Easy to Set Up and Take Down
- Anchor or Knot to keep Stability and Safety
- Lab-tested to Ensure Safety and Compliance with the Lead-Free Toys

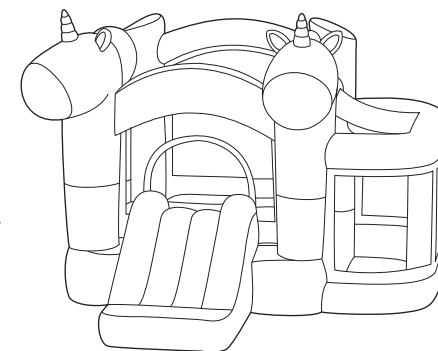

What's in the Box:

- Blower
- Repair Kits
- Plastic Stakes
- Bouncer
- Carrying bag

Technical Specs:

- Construction Material: 420D+840D Nylon
- Maximum Capacity: Up to 300 lbs.
- Recommended Age: 3 and Up
- Heavy Duty Blower: 450W (Recommended)
- Jumping Area Dimension (L x W x H): 61.02" x 57.09" x 15.75" -inches
- Slide Area Dimension (L x W x H): 36.93" x 42.91" x 19.67" -inches
- Overall Product Dimension (L x W x H): 106.3" x 98.43" x 70.87" -inches (Inflate)
- Product Dimension (L x W x H): 15.75" x 15.75" x 9.84" -inches (Deflate) 40x40x25cm

SLIS910

INFLATABLE BOUNCE WATER SLIDE

Outdoor Portable Bouncy Slide with Large Water Pool and Water Spray Function for Kids

FEATURES:

- Durable Climbing Wall
- Large Water Pool
- Water Splash Function
- Long Water Slide
- Quick to Inflate and Deflate
- Recommended Ages 3 and Up
- Suitable for 2 to 3 kids Play Together
- Easy Install and Safety Design
- Surrounded by Reinforced Net Sidewalls
- Comfortable to Touch
- Adopted High-Quality Sewing Technology
- Clean Easily with Soapy Water
- Durable and Smooth
- Exclusive High-strength Product Material
- Perfect Size with Enough Area for Water Play
- Suitable for Indoor and Outdoor
- Inflates in Less than a Minute
- Easy to Set Up and Take Down
- Anchor or Knot to keep Stability and Safety
- Lab-tested to Ensure Safety and Compliance with the Lead-Free Toys

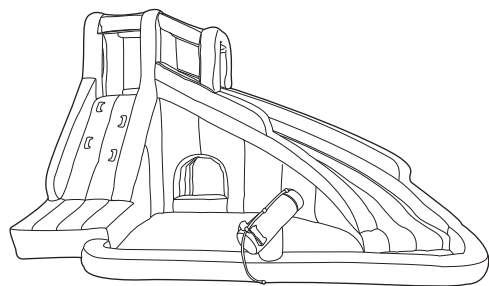

What's in the Box:

- Blower
- Plastic Stakes
- Carrying Bag
- Water Hose
- Repair Kits
- Bouncer
- Water Pipe

Technical Specs:

- Construction Material: 420D+840D Nylon
- Maximum Capacity: Up to 300lbs.
- Recommended Age: 3 and Up
- Heavy Duty Blower: 450W (Recommended)
- Water Pool Area Dimension (L x W x H): 81.22" x 75.98" -inches
- Slide Area Dimension (L x W x H): 158.46" x 22.05" x 50" -inches
- Overall Product Dimension (L x W x H): 157.48" x 118.11" x 90.55" -inches (Inflate)
- Product Dimension (L x W x H): 16.54" x 16.54" x 7.48" -inches (Deflate)

SLIS920

INFLATABLE BOUNCE WATER SLIDE

Outdoor Portable Bouncy Slide with Large Water Pool and Water Spray Function for Kids

FEATURES:

- Durable Climbing Wall
- Large Water Pool
- Water Splash Function
- Long Water Slide
- Quick to Inflate and Deflate
- Recommended Ages 3 and Up
- Suitable for 2 to 3 kids Play Together
- Easy Install and Safety Design
- Surrounded by Reinforced Net Sidewalls
- Comfortable to Touch
- Adopted High-Quality Sewing Technology
- Clean Easily with Soapy Water
- Durable and Smooth
- Exclusive High-strength Product Material
- Perfect Size with Enough Area for Water Play
- Suitable for Indoor and Outdoor
- Inflates in Less than a Minute
- Easy to Set Up and Take Down
- Anchor or Knot to keep Stability and Safety
- Lab-tested to Ensure Safety and Compliance with the Lead-Free Toys

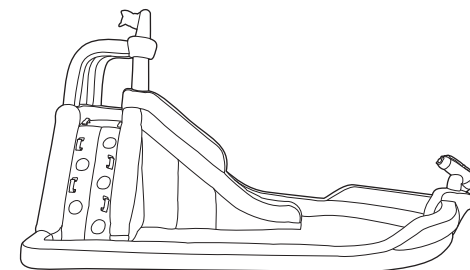

What's in the Box:

- Blower
- Plastic Stakes
- Carrying Bag
- Water Hose
- Repair Kits
- Bouncer
- Water Hose

Technical Specs:

- Construction Material: 420D+840D Nylon
- Maximum Capacity: Up to 300 lbs.
- Recommended Age: 3 and Up
- Heavy Duty Blower: 580W (Recommended)
- Water Pool Area Dimension (L x W x H): 134.13" x 47.24" -inches
- Slide Area Dimension (L x W x H): 86.61" x 22.05" x 47.24" -inches
- Overall Product Dimension (L x W x H): 188.98" x 100.39" x 106.3" -inches (Inflate)
- Product Dimension (L x W x H): 18.5" x 18.5" x 21.26" -inches (Deflate)