

Essential Storage Container Bin

Safety & Security Essential Storage Box
(37 Gal. Capacity)

serenelife™

USER GUIDE

Installation Instructions

Please read the instructions carefully before assembly and use. Clear the space for assembly and lay out all parts based on the Parts List. Ensure that all pieces are present.

1

Place the Bottom Panel on a clean, smooth surface. Insert front and back panel into bottom panel. Fasten card slot position respectively. Make sure the bottom and front panel is in correct position as shown in figure 1.

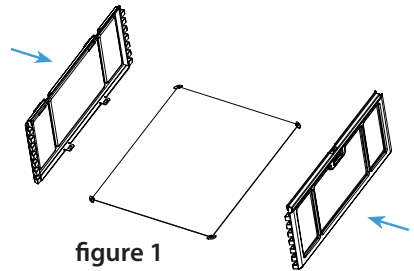

2

Next step, insert left and right panel into bottom panels corresponding card slot position and fasten as shown in figure 2.

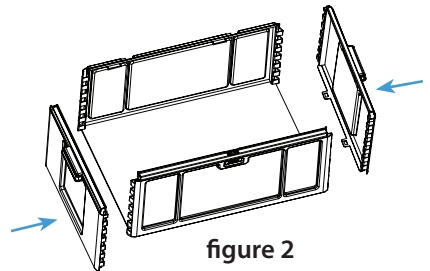

3

Insert the bolts on the assembled front, back and side panels and snap into place as shown in figure 3.

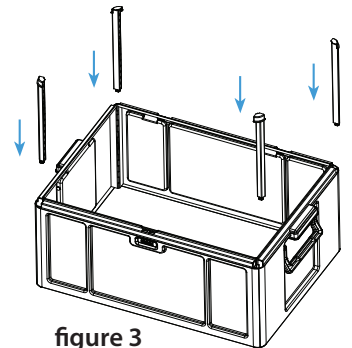

4

Finally, attach the cover into back panels corresponding spindle then finish assembly as shown in figure 4.

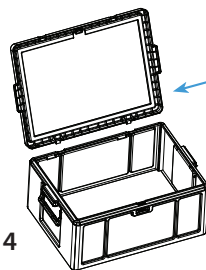
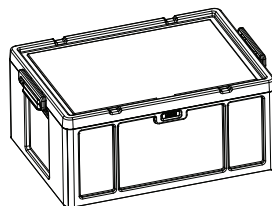

figure 4

5

You may set a password before use.



6

Set all rollers into "0" (initial password) to unlock. Randomize the strumming wheel to lock.

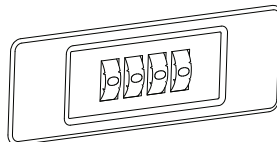

Set a new password: Set all rollers into "0", dial trigger to A position, set the new password that you want and make sure to write down & remember your code, then change the lever back from A to the B position. The setting of a new password is successful.

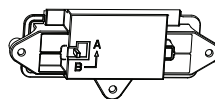

Questions? Issues?

We are here to help!

Phone: (1) 718-535-1800

Email: support@pyleusa.com